

<b>Title</b>	<b><i>Reference Design Report for a 26.5 W Isolated Flyback Power Supply Using TOPSwitch™-JX TOP267VG</i></b>
<b>Specification</b>	90 VAC – 265 VAC Input; 12.0 V / 2 A, 5 V / 500 mA Outputs
<b>Application</b>	Appliance
<b>Author</b>	Applications Engineering Department
<b>Document Number</b>	RDR-706
<b>Date</b>	February 2, 2022
<b>Revision</b>	1.0

### **Summary and Features**

- Dual output flyback topology
- No-load input power < 90 mW @ 230 VAC
- Integrate protection and reliability features
  - Auto recovery output over current (OCP) and short-circuit protection
  - Primary sensed output overvoltage shutdown (OVP) eliminates second optocoupler
  - Over temperature shutdown
  - Line undervoltage lock out (UVLO) and line overvoltage shutdown prevents output glitching and improves reliability
- 132 kHz operation optimizes core size and efficiency performance
- 84% < efficiency full Load @ nominal Lines
- 84.5% < average efficiency

### **PATENT INFORMATION**

The products and applications illustrated herein (including transformer construction and circuits external to the products) may be covered by one or more U.S. and foreign patents, or potentially by pending U.S. and foreign patent applications assigned to Power Integrations. A complete list of Power Integrations' patents may be found at [www.power.com](http://www.power.com). Power Integrations grants its customers a license under certain patent rights as set forth at <https://www.power.com/company/intellectual-property-licensing/>.

---

### **Power Integrations**

5245 Hellyer Avenue, San Jose, CA 95138 USA.  
Tel: +1 408 414 9200 Fax: +1 408 414 9201  
[www.power.com](http://www.power.com)

## Table of Contents

1	Introduction .....	4
2	Power Supply Specification .....	5
3	Schematic.....	6
4	Circuit Description .....	7
4.1	Input EMI Filtering and Rectification .....	7
4.2	TopSwitch-JX Primary .....	7
4.3	Output Rectification .....	8
4.4	Output Feedback .....	8
5	PCB Layout .....	9
6	Bill of Materials .....	10
6.1	Electrical BOM .....	10
6.2	Mechanical BOM .....	11
7	Transformer Specification .....	12
7.1	Electrical Diagram.....	12
7.2	Electrical Specifications .....	12
7.3	Material List .....	12
7.4	Transformer Build Diagram .....	13
7.5	Transformer Instructions.....	13
7.6	Transformer Winding Illustrations.....	14
9	Transformer Design Spreadsheet .....	18
10	Performance Data .....	21
10.1	Average Efficiency .....	21
10.1.1	Average Efficiency, 115 VAC.....	21
10.1.2	Average Efficiency, 230 VAC.....	21
10.2	Full Load Efficiency vs. Line.....	22
10.3	Efficiency vs. Load .....	23
10.4	No-Load Input Power.....	24
10.5	Line Regulation.....	25
10.6	Load Regulation .....	27
10.7	Cross Regulation.....	29
10.7.1	Cross Regulation with 12 V at Minimum Load and Varying 5 V Load.....	29
10.7.2	Cross Regulation with 12 V at Full Load and Varying 5 V Load .....	31
10.7.3	Cross Regulation with 5 V at Minimum Load and Varying 12 V Load.....	33
10.7.4	Cross Regulation with 5 V at Full Load and Varying 12 V Load .....	35
11	Waveforms.....	37
11.1	Load Transient Response .....	37
11.1.1	12 V Transient 10% - 100% Load Change (5 V, 100% Load).....	37
11.1.2	12 V Transient 50% - 100% Load Change (5 V, 100% Load).....	38
11.1.3	12 V Transient 10% - 100% Load Change (5 V, 10% Load) .....	39
11.1.4	12 V Transient 50% - 100% Load Change (5 V, 10% Load) .....	40
11.1.5	5 V Transient 10% - 100% Load Change (12 V, 100% Load).....	41
11.1.6	5 V Transient 50% - 100% Load Change (12 V, 100% Load).....	42
11.1.7	5 V Transient 10% - 100% Load Change (12 V, 10% Load) .....	43





11.1.8	5 V Transient 50% - 100% Load Change (12 V, 10% Load)	44
11.2	Output Start-up	45
11.2.1	Full Load CC Mode	45
11.2.2	Full Load CR Mode	46
11.2.3	0% Load	47
11.3	Switching Waveforms	48
11.3.1	Primary MOSFET Drain-Source Voltage and Current at Normal Operation	48
11.3.2	Primary MOSFET Drain-Source Voltage and Current at Start-up Operation	50
11.3.3	12 V Freewheeling Diode Voltage and Current at Normal Operation	52
11.3.4	5 V Freewheeling Diode Voltage and Current at Normal Operation	54
11.4	Brown-In and Brown-Out	56
11.5	Output Voltage Ripple	57
11.5.1	Ripple Measurement Technique	57
11.5.2	Measurement Results	58
11.5.3	12 V Output Ripple Voltage Graph from 10% - 100%	63
11.5.4	5 V Output Ripple Voltage Graph from 10% - 100%	64
12	Thermal Performance	65
12.1.1	90 VAC Full Load at Room Temperature	66
12.1.2	265 VAC Full Load at Room Temperature	67
12.1.3	90 VAC Full Load at 40 °C Ambient (Thermal Chamber)	68
12.1.4	265 VAC Full Load at 40 °C Ambient (Thermal Chamber)	69
13	Fault Condition	70
13.1	Output Short-Circuit Protection	70
13.2	Output Overvoltage Protection	73
13.3	Over Temperature Protection	74
14	Conducted EMI	76
14.1	Test Set-up Equipment	76
14.1.1	Equipment and Load Used	76
14.2	Output Float	77
14.3	Output Grounded	78
15	Line Surge	79
15.1	Differential Mode Surge	79
15.2	Common Mode Surge	80
16	ESD	80
17	Revision History	81

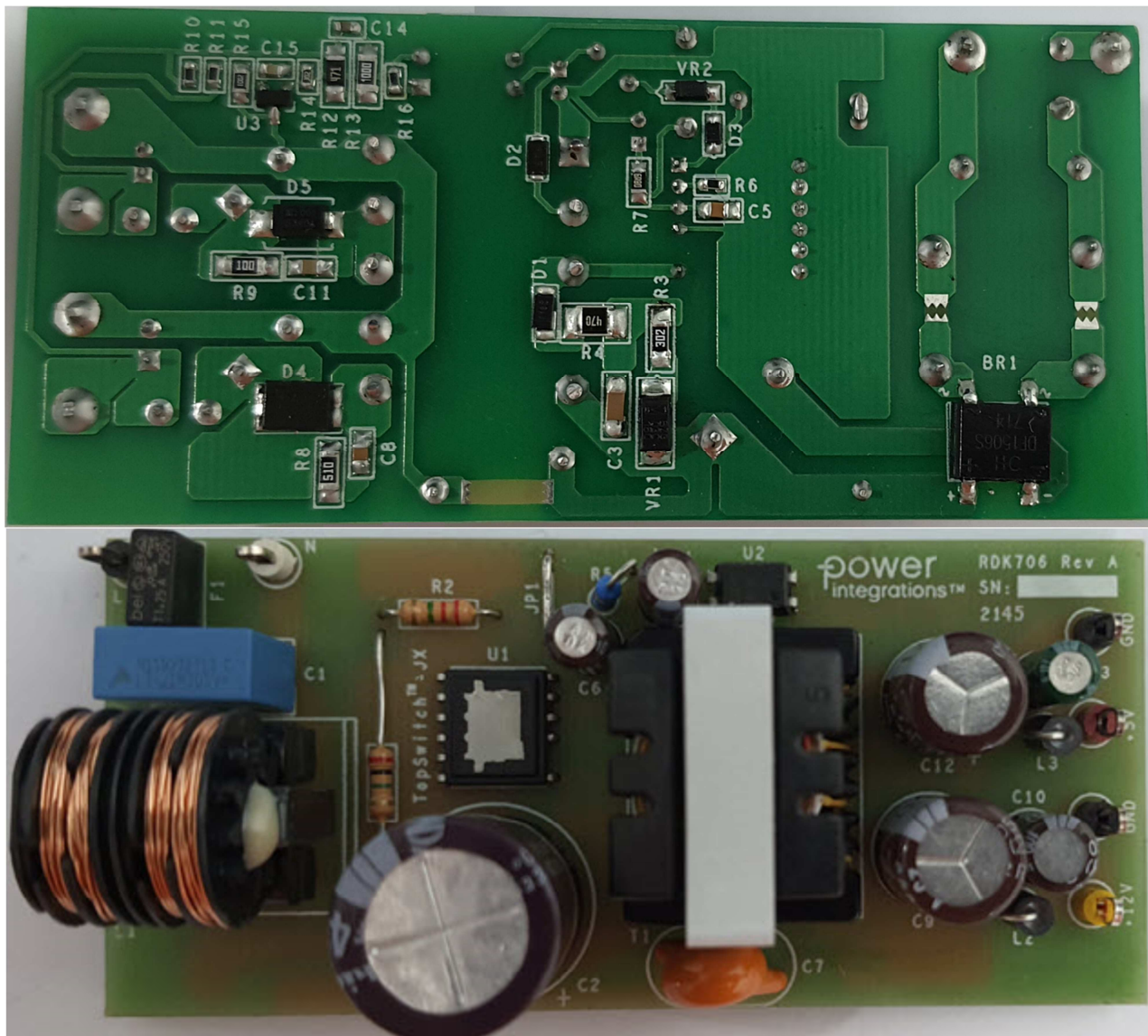
**Important Note:** Although this board is designed to satisfy safety isolation requirements, the engineering prototype has not been agency approved. Therefore, all testing should be performed using an isolation transformer to provide the AC input to the prototype board.



## 1 Introduction

This engineering report describes a flyback converter designed to provide an isolated nominal output voltage of 12 V at 2.0 A load and a second output of 5 V at 200 mA load from a wide input voltage range of 90 VAC to 265 VAC. This power supply utilizes the TOP267VG from the TOPSwitch-JX family of ICs.

This document contains the complete power supply specifications, bill of materials, transformer construction, circuit schematic and printed circuit board layout, along with performance data and electrical waveforms.



**Figure 1** – Populated Circuit Board.

## 2 Power Supply Specification

The table below represents the minimum acceptable performance of the design. Actual performance is listed in the results section.

Description	Symbol	Min	Typ	Max	Units	Comment
<b>Input</b>						
Voltage	$V_{IN}$	90		265	VAC	2 Wire – no P.E.
Frequency	$f_{LINE}$	47	50/60	64	Hz	
No-load Input Power (230 VAC)				100	mW	
<b>Output1</b>						
Output Voltage	$V_{OUT1}$	10.8	12	13.2	V	± 10% 20 MHz Bandwidth.
Output Ripple Voltage	$V_{RIPPLE1}$			120	mV	
Output Current	$I_{OUT1}$	200		2000	mA	
<b>Output2</b>						
Output Voltage2	$V_{OUT2}$	4.75	5	5.25	V	± 5% 20 MHz Bandwidth.
Output Ripple Voltage2	$V_{RIPPLE2}$			50	mV	
Output Current2	$I_{OUT2}$	50		500	mA	
<b>Total Output Power</b>						
Continuous Output Power	$P_{OUT}$			26.5	W	
<b>Efficiency</b>						
Full Load Nominal Input	$\eta$	84			%	Measured at $P_{OUT}$ 25 °C.
Required average efficiency at 25, 50, 75 and 100 % of $P_{OUT}$	$\eta_{DOE}$	84.5			%	Measured at Nominal Input 115 VAC and 230 VAC.
<b>Environmental</b>						
Conducted EMI		Meets CISPR22B / EN55022B				1.2/50 $\mu$ s Surge, IEC 61000-4-5, Series Impedance: Differential Mode: 2 $\Omega$ . Common Mode: 12 $\Omega$ . Free Convection, Sea Level.
Surge (Differential)				1	kV	
Surge (Common Mode)				2	kV	
Ambient Temperature	$T_{AMB}$	0		40	°C	

### 3 Schematic

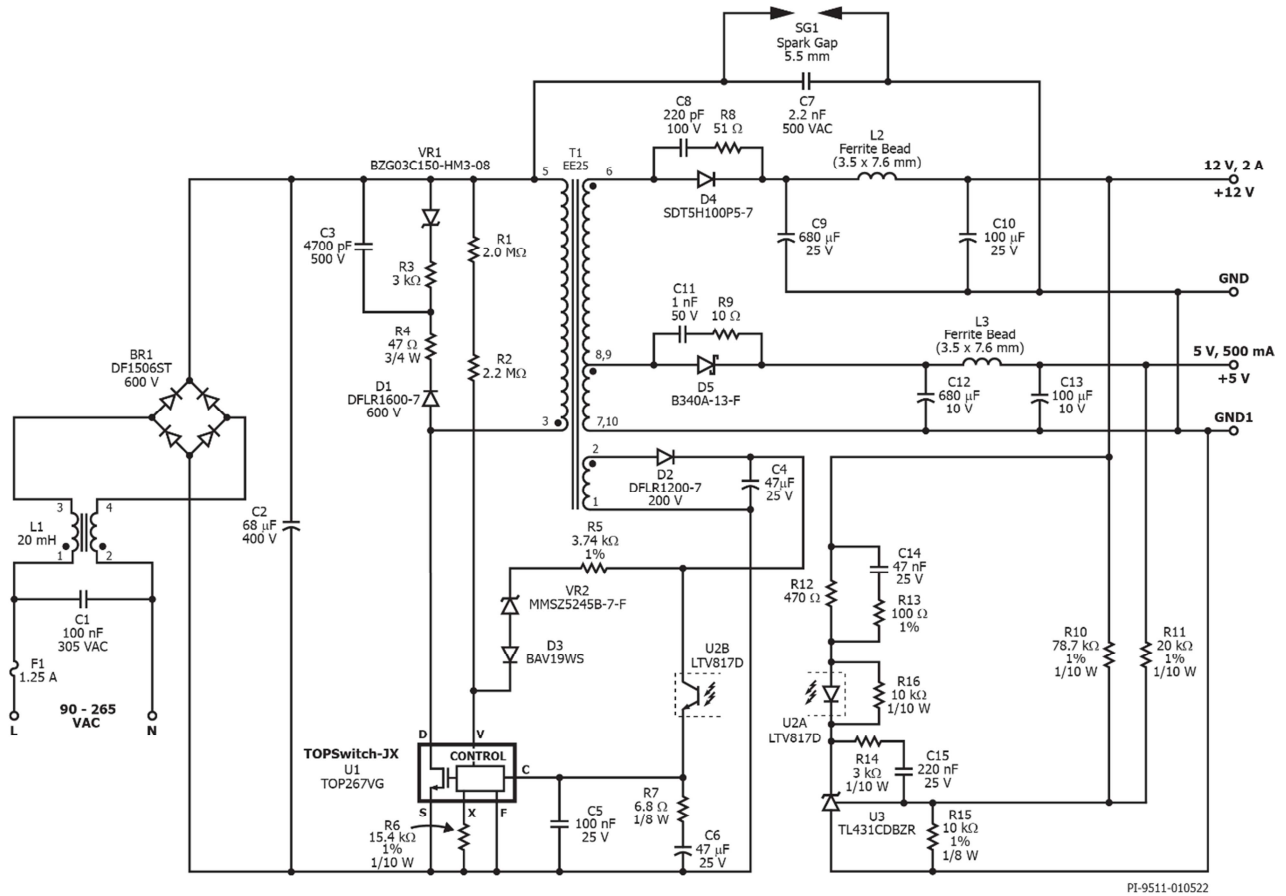


Figure 2 – Schematic.



## 4 Circuit Description

This power supply employs a TOP267VG off-line switcher, (U1), in a flyback configuration. IC U1 has an integrated 725 V power MOSFET and a multi-mode controller. It regulates the output by adjusting the power MOSFET duty cycle, based on the current fed into its CONTROL pin.

### 4.1 *Input EMI Filtering and Rectification*

Fuse F1 isolates the circuit and provides protection from component failure. X capacitor C1 together with common mode choke L1 forms an EMI filter that attenuates both common mode and differential mode conducted EMI. BR1 converts the AC line voltage into the DC voltage seen across capacitors C2.

### 4.2 *TopSwitch-JX Primary*

The TOP267VG device (U1) integrates an oscillator, a switch controller, start-up and protection circuitry, and a power MOSFET, all on one monolithic IC. One side of the power transformer (T1) primary winding is connected to the positive side of the bulk capacitors C2, and the other side are connected to the DRAIN pin of U1. When the MOSFET turns off, the leakage inductance of the transformer induces a voltage spike on the drain node. The spike amplitude is limited by a RZCD clamp network that consists of D1, R4, VR1, R3 and C3. The RZCD arrangement prevents the voltage across the capacitor C3 discharging below a minimum value (defined by the voltage rating of VR1) and therefore minimizing clamp dissipation under light and no-load conditions. Resistor R4 is used together with capacitor C3 to damp out high frequency ringing and improve EMI. This arrangement was selected to reduce clamp losses under light and no-load conditions.

The TOP267VG regulates the output by adjusting the duty cycle based on the current into its CONTROL pin. The power supply output voltage is sensed on the secondary-side by shunt regulator U3 and provides a feedback signal to the primary side through optocoupler U2.

The line undervoltage is determine by the current supplied from resistors R1 and R2 to the V pin. R5, VR2, and D3 are used for output overvoltage protection. An increase in output voltage causes an increase in the bias winding on the primary-side, sensed by VR2. Once VR2 is activated, it will inject current to the V pin causing the IC to shut down and undergo auto-restart.

Capacitor C6 provides the auto-restart timing for U1, start-up and loop compensation. At start-up, this capacitor is charged through the DRAIN (D) pin. Once it is charged, U1 begins to switch. Capacitor C6 stores enough energy to ensure the power supply output reaches regulation. After start-up, the bias winding powers the controller via the current through the optocoupler into the CONTROL pin. Bypass capacitor C5 is placed as



physically close as possible to U1. Resistor R7 provides additional compensation to the feedback loop.

X pin resistor R6 was used to reduce the current limit to a value close to the operating peak current. This allows the supply to limit the output power at high line and deliver the rated output at low line.

#### 4.3 ***Output Rectification***

Schottky diodes D4 rectify the 12 V secondary winding output of T1. The output voltage is filtered by C9, L2, and C10. Resistor R8 and capacitor C8 snubs the voltage spike caused by the commutation of D4. Schottky diode D5 rectifies the 5 V secondary winding output of T1. The output voltage is filtered by C12, L3, and C13. Resistor R9 and capacitor C11 absorb the noise caused by the commutation of D5.

A low voltage rating diode was achievable for D4 and D5 due to the flexibility of a higher turns ratio (higher VOR). This is realized due to the 725 V rating of the MOSFET in U1. This also further improves efficiency due to the low forward voltage drop ( $V_F$ ) of the low voltage diode.

#### 4.4 ***Output Feedback***

The reference IC, U3 or TL431 is used to set the two output voltages programmed via the resistor divider R10, R11 and R15. A portion of both 12 V and the 5 V outputs are fed into the shunt regulator U3 or TL431. The TL431 varies its cathode voltage to keep its input voltage constant (equal to 2.495 V,  $\pm 2.2\%$ ). As the cathode voltage changes, the current through the LED and transistor within U3 change. A high CTR opto-coupler was selected for U2 to minimize the secondary-side feedback (opto) current and thereby reduce no-load and standby input power. Capacitor C15 and R14 provide compensation for the feedback control loop. Capacitor C14 and R13 is a phase boost network to improve the phase margin of the unit. Resistor R12 limits the gain of the feedback system to ensure power supply stability throughout the range of operation.

Good cross-regulation on 12 V and 5 V outputs are achieved by AC-stacked the secondary windings 12 V and 5 V and sensing feedback from both outputs.

## 5 PCB Layout

1 Layer PCB, 1.6 mm Board Thickness, FR4 Material, 2 oz Copper Thickness

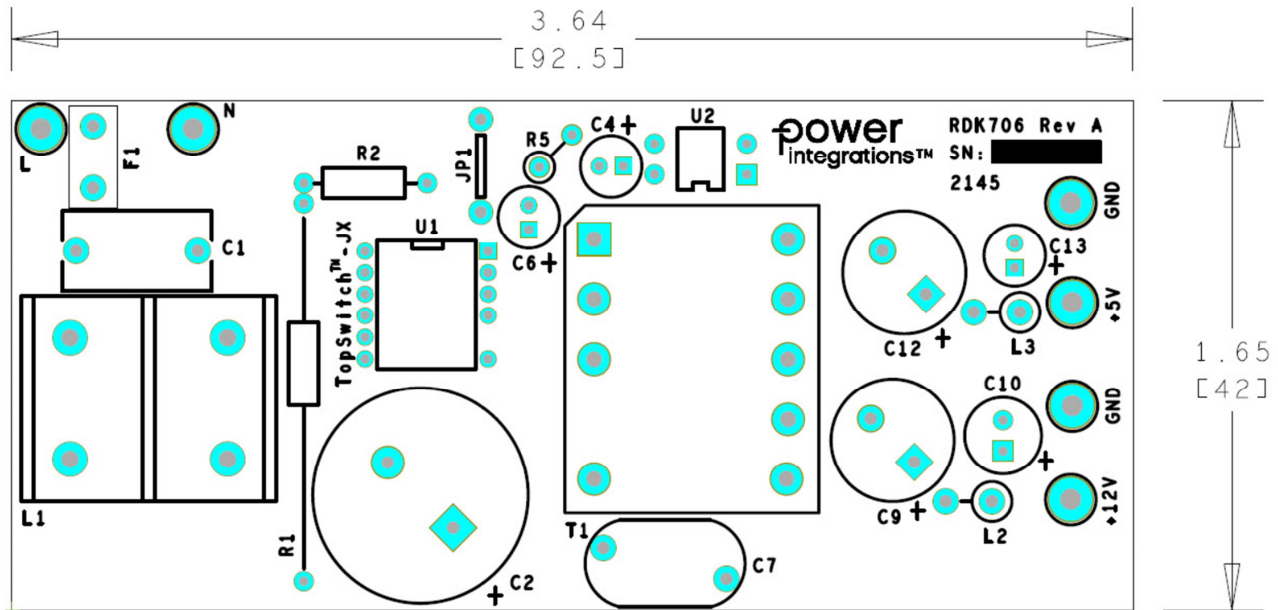


Figure 3 – Printed Circuit Board, Top View.

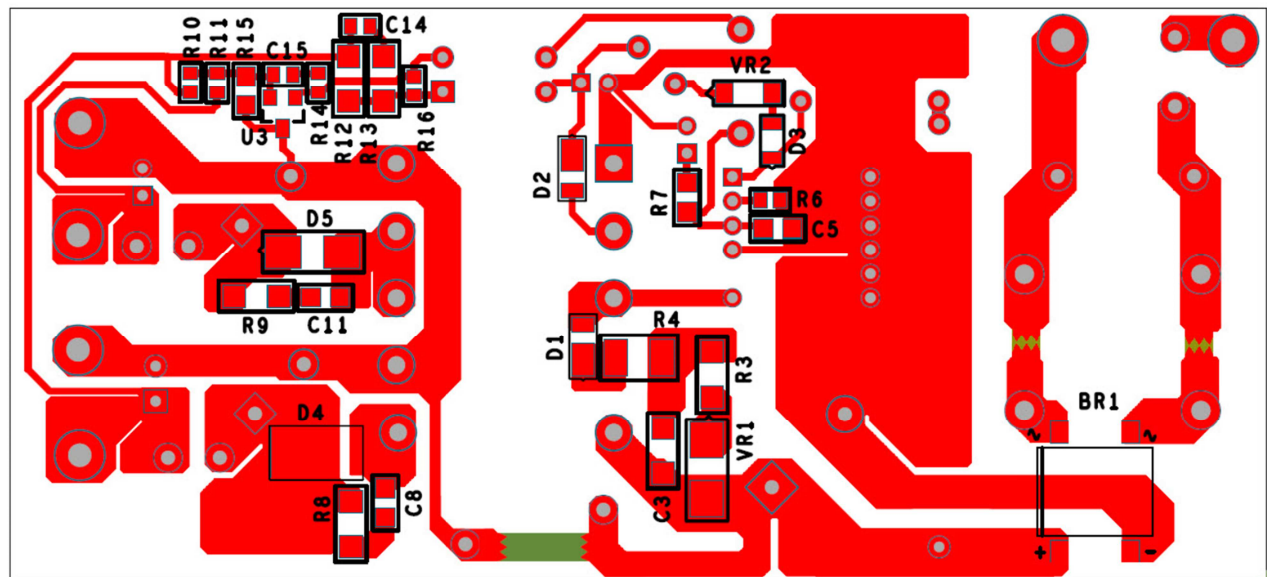


Figure 4 – Printed Circuit Board, Bottom View.

## 6 Bill of Materials

### 6.1 Electrical BOM

Item	Qty	Ref Des	Description	Mfg Part Number	Mfg
1	1	BR1	BRIDGE RECT, 1PH, 1.5 A, 600 V, Vf = 1.1 V @ 1.5 A, -65 °C ~ 150 °C (TJ), DF-S,4-SMD	DF1506S-T	Diodes, Inc.
2	1	C1	100 nF, 305 VAC, Film, X2	B32921C3104M	Epcos
3	1	C2	68 µF, 400 V, Electrolytic, Low ESR, 530 mΩ, (18 x 25)	EKMX401ELL680MM25S	Nippon Chemi-Con
4	1	C3	4700 pF ±5% 500 V Ceramic COG, NP0 1206	C1206C472JCGCAUTO	Kemet
5	2	C4 C6	47 µF, 25 V, Electrolytic, Very Low ESR, 300 mΩ, (5 x 11)	EKZE250ELL470ME11D	Nippon Chemi-Con
6	1	C5	100 nF, 25 V, Ceramic, X7R, 0805	08053C104KAT2A	AVX
7	1	C7	2200 pF, ±20%, 500 VAC (Y1),760 VAC (X1), Ceramic, Y5U €, RADIAL	440LD22-R	Vishay
8	1	C8	220 pF, 100 V, Ceramic, X7R, 0805	08051C221KAT2A	AVX
9	1	C9	680 µF, 25 V, Electrolytic, Very Low ESR, 32 mΩ, (10 x 16)	EKZH250EC3681MJ16S	Nippon Chemi-Con
10	1	C10	100 µF, 25 V, Electrolytic, Very Low ESR, 130 mΩ, (6.3 x 11)	EKZE250ELL101MF11D	Nippon Chemi-Con
11	1	C11	1 nF, 50 V, Ceramic, X7R, 0805	08055C102KAT2A	AVX
12	1	C12	680 µF, 10 V, Electrolytic, Very Low ESR, 53 mΩ, (10 x 12.5)	EKZE100ELL681MJC5S	Nippon Chemi-Con
13	1	C13	100 µF, 10 V, Electrolytic, Very Low ESR, 300 mΩ, (5 x 11)	EKZE100ELL101ME11D	Nippon Chemi-Con
14	1	C14	47 nF 25 V, Ceramic, X7R, 0603	CC0603KRX7R8BB473	Yago
15	1	C15	220 nF, 25 V, Ceramic, X7R, 0603	06033D224KAT2A	AVX
16	1	D1	600 V, 1 A, Rectifier, Glass Passivated, POWERDI123	DFLR1600-7	Diodes, Inc.
17	1	D2	200 V, 1 A, Rectifier, Glass Passivated, POWERDI123	DFLR1200-7	Diodes, Inc.
18	1	D3	100 V, 0.2 A, Fast Switching, 50 ns, SOD-323	BAV19WS-7-F	Diodes, Inc.
19	1	D4	100 V, 5 A, Schottky, SMD, POWERD15, PowerDI™ 5	SDT5H100P5-7	Diodes, Inc.
20	1	D5	Diode, SCHOTTKY, 40 V, 3 A, SMA, DO-214AA	B340A-13-F	Diodes, Inc.
21	1	F1	FUSE, 1.25 A 250 VAC, Slow, 8.35 mm x 4.0 mm x 7.7 mm	RST 1.25-BULK	Bel Fuse
22	1	L1	20 mH, 0.8 A, Common Mode Choke	SS21V-R080200	KEMET
23	2	L2 L3	3.5 mm x 7.6 mm, 75 Ω at 25 MHz, #22 AWG hole, Ferrite Bead	2743004112	Fair-Rite
24	1	R1	RES, 2.0 MΩ, 5%, 1/4 W, Carbon Film	CFR-25JB-2M0	Yageo
25	1	R2	RES, 2.2 MΩ, 5%, 1/4 W, Carbon Film	CFR-25JB-2M2	Yageo
26	1	R3	RES, 3.0 kΩ, 5%, 1/4 W, Thick Film, 1206	ERJ-8GEYJ302V	Panasonic
27	1	R4	RES, 47 Ω, ±5%, 0.75 W, 1210, Pulse Withstanding, Thick Film	CRCW121047R0JNEAHP	Vishay
28	1	R5	RES, 3.74 kΩ, 1%, 1/4 W, Metal Film	MFR-25FBF-3K74	Yageo
29	1	R6	RES, 15.4 kΩ, 1%, 1/10 W, Thick Film, 0603	ERJ-3EKF1542V	Panasonic
30	1	R7	RES, 6.8 Ω, 5%, 1/8 W, Thick Film, 0805	ERJ-6GEYJ6R8V	Panasonic
31	1	R8	RES, 51 Ω, 5%, 1/4 W, Thick Film, 1206	ERJ-8GEYJ510V	Panasonic
32	1	R9	RES, 10 Ω, 5%, 1/4 W, Thick Film, 1206	ERJ-8GEYJ100V	Panasonic
33	1	R10	RES, 78.7 kΩ, 1%, 1/10 W, Thick Film, 0603	ERJ-3EKF7872V	Panasonic
34	1	R11	RES, 20 kΩ, 1%, 1/10 W, Thick Film, 0603	ERJ-3EKF2002V	Panasonic
35	1	R12	RES, 470 Ω, 5%, 1/4 W, Thick Film, 1206	ERJ-8GEYJ471V	Panasonic
36	1	R13	RES, 100 Ω, 1%, 1/4 W, Thick Film, 1206	ERJ-8ENF1000V	Panasonic
37	1	R14	RES, 3 kΩ, 5%, 1/10 W, Thick Film, 0603	ERJ-3GEYJ302V	Panasonic
38	1	R15	RES, 10.0 kΩ, 1%, 1/8 W, Thick Film, 0805	ERJ-6ENF1002V	Panasonic
39	1	R16	RES, 10 kΩ, 5%, 1/10 W, Thick Film, 0603	ERJ-3GEYJ103V	Panasonic
40	1	T1	Bobbin, EE25, Vertical, 10 pins Transformer	YW-360-02B POL-JX042	Yih-Hwa Enterprises Premier Magnetics
41	1	U1	TopSwitch-JX, eDIP-12P	TOP267VG	Power Integrations
42	1	U2	Optocoupler, 35 V, CTR 300-600%, 4-DIP	LTV-817D	Liteon
43	1	U3	IC, Shunt Regulator Adj., 2.495 V, 2.2%, 100 mA, 0 °C ~ 70 °C (TA), SOT23-3, TO-236-3, SC-59, SOT-23-3	TL431CDBZR	Texas Instruments
44	1	VR1	Zener Diode, 150 V, 1.25 W, ±6%, SMT, DO-214AC (SMA)	BZG03C150-HM3-08	Vishay
45	1	VR2	Diode Zener 15 V 500 mW SOD123	MMSZ5245B-7-F	Diodes, Inc.



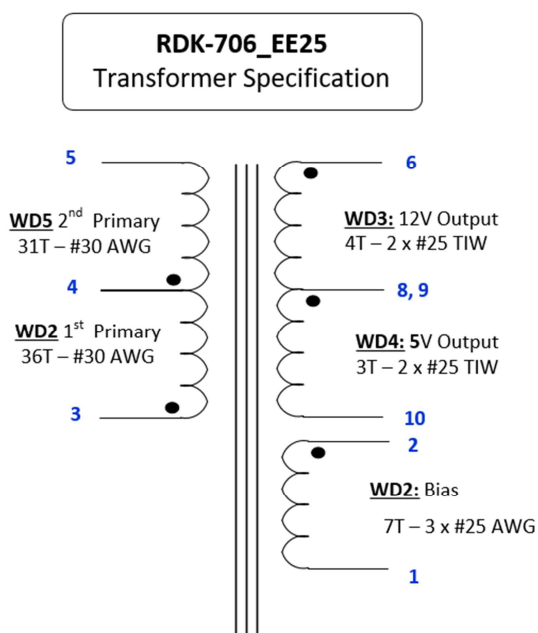


**6.2 Mechanical BOM**

<b>Item</b>	<b>Qty</b>	<b>Ref Des</b>	<b>Description</b>	<b>Mfg Part Number</b>	<b>Mfg</b>
1	1	+12 V	Test Point, YEL, THRU-HOLE MOUNT	5014	Keystone
2	1	+5 V	Test Point, RED, THRU-HOLE MOUNT	5010	Keystone
3	3	GND1, GND, L	Test Point, BLK, THRU-HOLE MOUNT	5011	Keystone
4	1	JP1	Wire Jumper, Non-insulated, #26 AWG, 0.3 in	299/1 SV001	Alpha Wire
5	1	N	Test Point, WHT, THRU-HOLE MOUNT	5012	Keystone

## 7 Transformer Specification

### 7.1 Electrical Diagram



**Figure 5** – Transformer Electrical Diagram.

### 7.2 Electrical Specifications

Parameter	Condition	Spec.
Nominal Primary Inductance	Measured at 1 V <sub>PK-PK</sub> , 100 kHz switching frequency, between pin 1 and pin 3 with all other windings open.	535 $\mu$ H
Tolerance	Tolerance of primary inductance.	$\pm$ 5%
Leakage Inductance	Measured across primary winding with all other windings shorted.	<8 $\mu$ H

### 7.3 Material List

Item	Description
[1]	Core: EE25 TDK PC40
[2]	Bobbin: EE2, Vertical, 10 pins (Mfg PN: YW-360-02B, Mfg: Yih-Hwa Enterprises)
[3]	Magnet Wire: #30 AWG.
[4]	Magnet Wire: #25 AWG.
[5]	TIW Wire: #25 AWG.
[6]	Polyester Tape: 10.7 mm.
[7]	Polyester Tape: 7 mm.
[8]	Varnish: Dolph BC 359 or Equivalent.

#### 7.4 Transformer Build Diagram

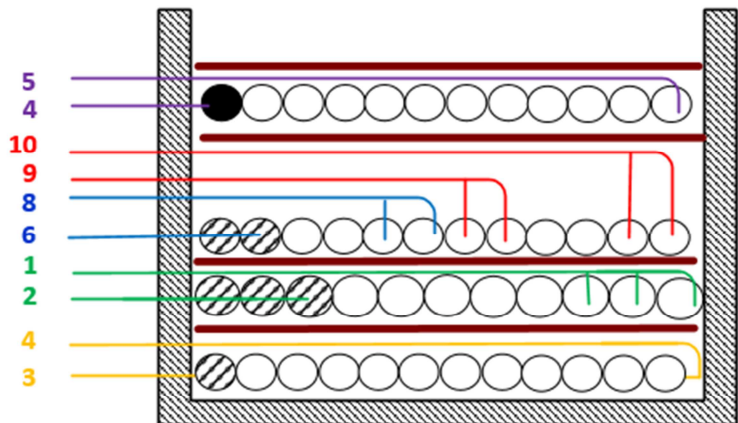
**WD5** 2<sup>nd</sup> Primary 31T – #30 AWG

**WD4:** 5V Output 3T – 2 x #25 TIW

**WD3:** 12V Output 4T – 2 x #25 TIW

**WD2:** Bias 7T – 3 x #25 AWG

**WD1** 1<sup>st</sup> Primary 36T – #30 AWG



**Note:**

Bobbin: EE25 Vertical, 10 pins

Core: EE25 TDK PC40

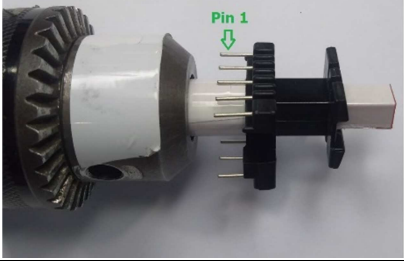
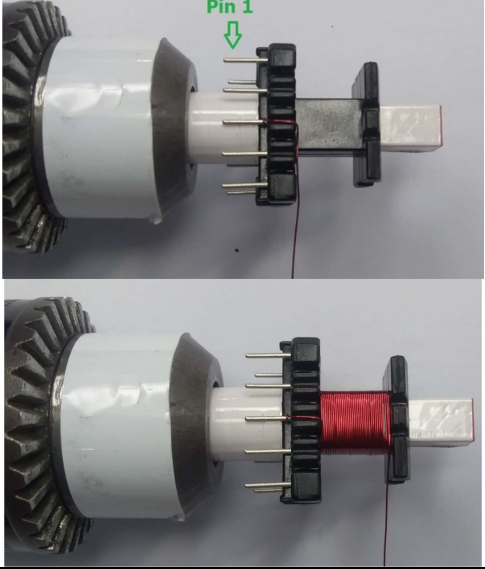
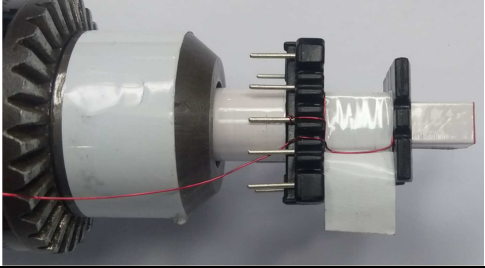
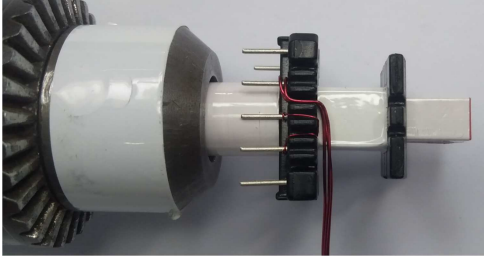
L<sub>p</sub>: 535 μH

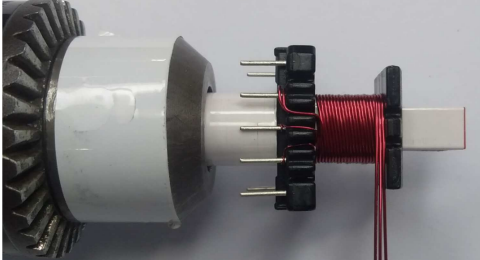
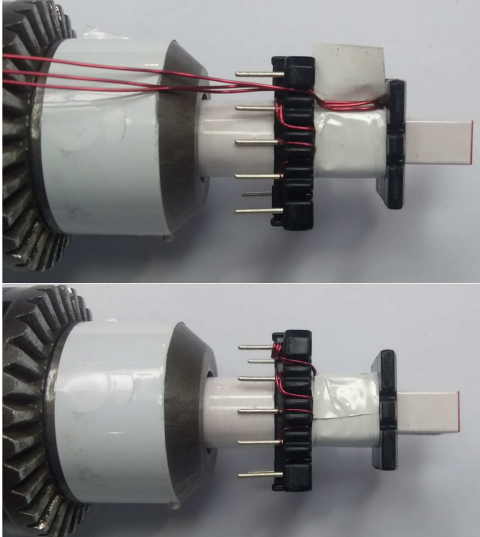
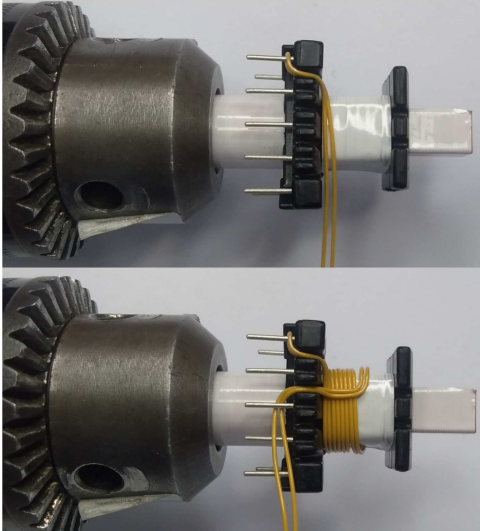
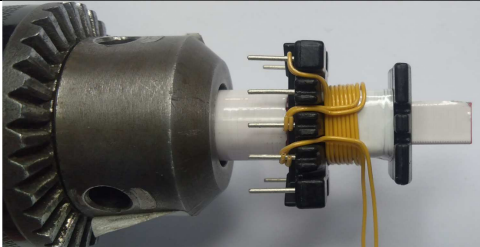
**Figure 6** – Transformer Build Diagram.

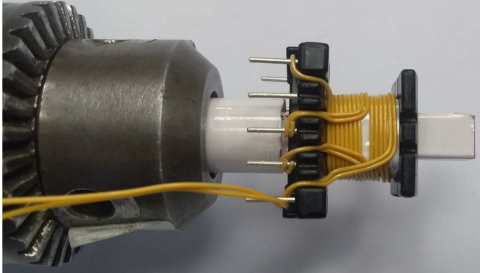
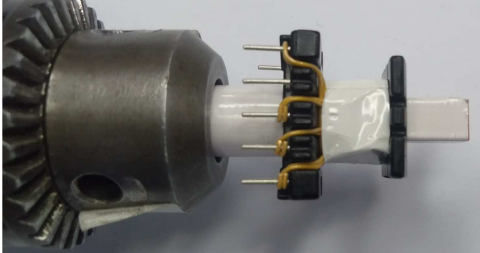
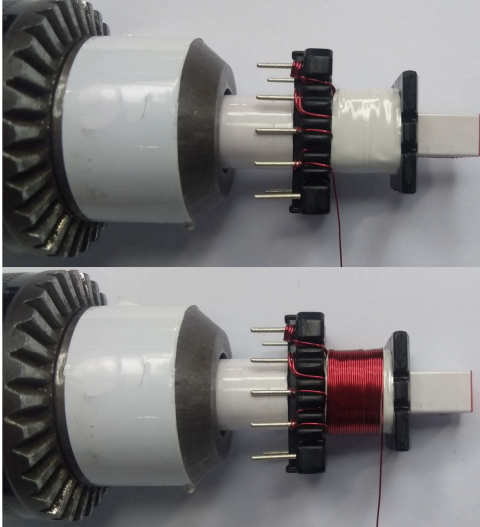
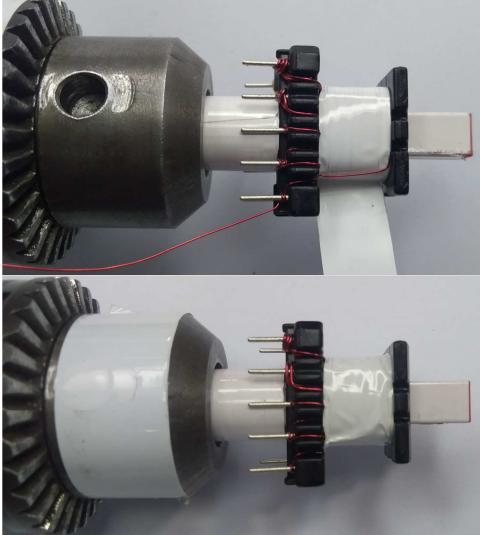
#### 7.5 Transformer Instructions


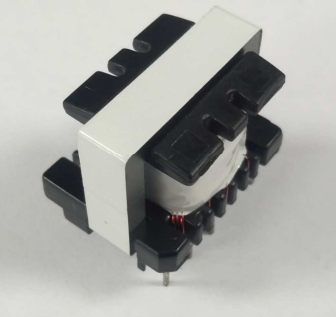
<b>Bobbin Preparation</b>	For the purposes of these instructions, bobbin is oriented on winder such that pin 1 to 5 is located on the top side. Winding direction is clockwise.
<b>WD1 1<sup>st</sup> Primary</b>	Start at pin 3, wind 36 turns of wire Item [3] in 1 layers.
<b>Insulation</b>	Finish WD1 at pin 4. Use 1 layer of tape Item [6] for insulation.
<b>WD2 Bias</b>	Prepare 3 strands of wire Item [4]. Start 3 strands of wire Item [4] at pin 2, wind 3 wires 7 turns in parallel in 1 layer.
<b>Insulation</b>	Finish WD2 at pin 1. Use 1 layer of tape Item [6] for insulation.
<b>WD3 12 V Output</b>	Prepare 2 strands of wire Item [5]. Start 2 strands of wire Item [5] at pin 6, wind 2 wires 4 turns in parallel in 1 layer. Finish at pin 8.
<b>WD4 5 V Output</b>	Prepare 2 strands of wire Item [5]. Start 2 strands of wire Item [5] at pin 9, wind 2 wires 3 turns in parallel in 1 layer. Finish at pin 10.
<b>Insulation</b>	Use 1 layer of tape Item [6] for insulation.
<b>WD5 2<sup>nd</sup> Primary</b>	Start at pin 4, wind 31 turns of wire Item [3] in 1 layer.
<b>Insulation</b>	Finish WD5 at pin 5. Use 1 layer of tape Item [6] for insulation.
<b>Solder and Cut Pin</b>	Solder the wires to the leads of the bobbin and cut Pin 4
<b>Finish</b>	Gap cores to get 535 μH. Wrap the body of transformer with 3 layers of tape Item [7]. Varnish using Item [8].

7.6 **Transformer Winding Illustrations**

<p><b>Bobbin Preparation</b></p>	 <p>A photograph of a transformer bobbin on a winder. A green arrow points to the top pin, labeled 'Pin 1'. A yellow curved arrow indicates a clockwise winding direction.</p>	<p>For the purposes of these instructions, bobbin is oriented on winder such that pin 1 to 5 is located on the top side. Winding direction is clockwise.</p>
<p><b>WD1 1<sup>st</sup> Primary</b></p>	 <p>Two photographs showing the winding process. The top photo shows the start at pin 3 with a green arrow labeled 'Pin 1'. The bottom photo shows a completed red wire winding on the bobbin.</p>	<p>Start at pin 3, wind 36 turns of wire Item [3] in 1 layers.</p>
<p><b>Insulation</b></p>	 <p>A photograph showing a white insulating tape being applied over the red wire winding on the bobbin.</p>	<p>Finish WD1 at pin 4 Use 1 layer of tape Item [6] for insulation.</p>
<p><b>WD2 Bias</b></p>	 <p>A photograph showing three red wires being wound in parallel on the bobbin.</p>	<p>Prepare 3 strands of wire Item [4]. Start 3 strands of wire Item [4] at pin 2, wind 3 wires 7 turns in parallel in 1 layer.</p>

		
<p><b>Insulation</b></p>		<p>Finish WD2 at pin 1 Use 1 layer of tape Item [6] for insulation.</p>
<p><b>WD3 12 V Output</b></p>		<p>Prepare 2 strands of wire Item [5]. Start 2 strands of wire Item [5] at pin 6, wind 2 wires 4 turns in parallel in 1 layer. Finish at pin 8.</p>
<p><b>WD4 5 V Output</b></p>		<p>Prepare 2 strands of wire Item [5]. Start 2 strands of wire Item [5] at pin 9, wind 2 wires 3 turns in parallel in 1 layer. Finish at pin 10.</p>

		
<p><b>Insulation</b></p>		<p>Use 1 layer of tape Item [6] for insulation.</p>
<p><b>WD5 2<sup>nd</sup> Primary</b></p>		<p>Start at pin 4, wind 31 turns of wire Item [3] in 1 layers.</p>
<p><b>Insulation</b></p>		<p>Finish WD5 at pin 5. Use 1 layer of tape Item [6] for insulation.</p>

<p><b>Solder and Cut Pin</b></p>		<p>Solder the wires to the leads of the bobbin and cut Pin 4</p>
<p><b>Finish</b></p>		<p>Gap cores to get 535 uH. Wrap the body of transformer with 3 layers of tape Item [7]. Varnish using Item [8].</p>

## 9 Transformer Design Spreadsheet

1	ACDC_TOPSwitchJX_062521; Rev.2.1; Copyright Power Integrations 2021	INPUT	INFO	OUTPUT	UNITS	TOPSwitch-JX Flyback Design Spreadsheet
2	<b>Application Variables</b>					
3	VAC_RANGE			Universal		Input voltage range
4	VAC_MIN	90		90	V	Minimum input RMS voltage
5	VAC_MAX	265		265	V	Maximum input RMS voltage
6	FL			50	Hz	Line frequency
7	VOUT	12.00		12.00	V	Output voltage
8	IOUT			2.21	A	Output current
9	POUT	26.5		26.5	W	Output power
10	POUT_PEAK			26.5	W	Peak output power
11	EFFICIENCY_ACDC			0.86		AC-DC efficiency
12	FACTOR_Z			0.50		Z-factor
15	<b>Input Side Components</b>					
16	<b>Input Capacitor</b>					
17	CIN	68.0		68.0	uF	Input capacitance
18	VF_BRIDGEDIODE			0.70	V	Input bridge diode forward voltage
19	VAC_MIN_VLY			96.2	V	Valley of the rectified minimum input AC voltage when delivering POUT. During peak power delivery, the valley of the rectified minimum input AC voltage is 96.2V
21	<b>V-Pin</b>					
22	UVOV TYPE	UVOV		UVOV		Standard under-voltage and over-voltage. Refer to page.13 of the TopSwitch-JX spreadsheet
23	UNDERVOLTAGE			65.6 - 82.5	V	Actual RMS under-voltage range
24	OVERVOLTAGE			316.7 - 353.7	V	Actual RMS over-voltage range
25	RLS1			4.22	MΩ	1% resistor connected from the rectified line voltage to the V-pin
26	RLS2			NA	kΩ	Not required
28	<b>X-Pin</b>					
29	KI			0.37 - 0.56		Typical current limit reduction factor target
30	ILIMIT_KI_RANGE			1.036 - 1.804	A	Minimum current limit based on KI
31	RIL			15.40	kΩ	Current limit programming resistor (1%) connected to the X-pin. Refer to page.31 of the TOPSwitch-JX datasheet
32	RPL			NA	MΩ	Power limiting resistor (1%) connected from the rectified input voltage to the X-pin. Refer to page.14 of the TOPSwitch-JX datasheet
34	<b>Bias Winding</b>					
35	VBIAS			12.00	V	Target rectified bias winding voltage at low-load
36	VF_BIAS			0.70	V	Bias winding rectifier diode on-time voltage drop
37	VBIAS_OVP			18.00	V	Target rectified bias winding voltage to trigger output over-voltage
38	VZ_OVP			16.00	V	Zener voltage (1%) required for bias winding sensed output over-voltage. Refer to fig.15 in the TOPSwitch-JX datasheet
39	R_OVP			3.74	kΩ	Resistor (1%) required for bias winding sensed output over-voltage. Refer to fig.15 in the TOPSwitch-JX datasheet
42	<b>TOPSwitch-JX</b>					
43	PACKAGE	eDIP-		eDIP-12B		TOPSwitch Package





		12B				
44	HEATSINK	PCB		PCB		TOPSwitch Heatsink
45	ENCLOSURE	Open Frame		Open Frame		Power supply enclosure
46	MODE_FREQUENCY	F		F		Frequency operation mode (F=132kHz, H=66kHz)
47	DEVICE	TOP267		TOP267VG		TOPSwitch device
48	PMAX			32	W	TOPSwitch device maximum power capability
49	ILIMIT_MIN			2.800	A	Minimum TOPSwitch current limit
50	ILIMIT_MAX			3.222	A	Maximum TOPSwitch current limit
51	VDSOIN			1.085	V	TOPSwitch on-time drain to source voltage
52	VDSOFF			543.4	V	TOPSwitch off-time drain to source voltage
<b>55</b>	<b>Electrical Parameters (Worst Case)</b>					
56	KP			0.752		Measure of continuous/discontinuous mode of operation. The actual KP calculated based on tolerance may be lower than the value entered
57	DUTY			0.558		Primary switch duty cycle
58	I <sub>AVG_PRI</sub>			0.301	A	Primary switch average current
59	I <sub>PK_PRI</sub>			0.979	A	Primary switch peak current
60	I <sub>RMS_PRI</sub>			0.446	A	Primary Switch RMS current
61	I <sub>IRIPPLE_PRI</sub>			0.974	A	Primary Switch ripple current
62	I <sub>PK_SEC</sub>			9.371	A	Secondary rectifier peak current
63	I <sub>RMS_SEC</sub>			3.797	A	Secondary winding RMS current
<b>66</b>	<b>Transformer</b>					
67	LP_TYP			534.6	uH	Typical primary magnetizing inductance
68	LP_RANGE			507.9 - 561.3	uH	Range of primary magnetizing inductance to ensure power delivery
69	LP_TOL			5.0	%	Magnetizing inductance tolerance
70	VOR			120.0	V	Secondary winding voltage reflected to the primary winding
<b>72</b>	<b>Core/Bobbin Selection</b>					
73	CORE	Custom		Custom		Transformer core selection - refer to the Transformer Parameters tab to verify fit
74	CORE CODE	B-EE25-H		B-EE25-H		Core code
75	AE	41.0		41.0	mm <sup>2</sup>	Core cross sectional area
76	LE	47.0		47.0	mm	Core magnetic path length
77	AL	2140		2140	nH/turns <sup>2</sup>	Ungapped core effective inductance
78	VE	0		0	mm <sup>3</sup>	Core volume
79	BOBBIN	B-EE25-H		B-EE25-H		Bobbin
80	AW	60.67		60.67	mm <sup>2</sup>	Window area of the bobbin
81	BW	10.72		10.72	mm	Bobbin width
82	MARGIN	0.00		0.00	mm	Safety margin width (Half the primary to secondary creepage distance)
<b>84</b>	<b>Winding Parameters</b>					
85	NP			67		Primary winding number of turns
86	NB			7		Bias winding number of turns
87	NS			7		Secondary winding number of turns
88	BPEAK			0.3687	T	Transformer core's peak flux density
89	BMAX			0.1915	T	Transformer core's operating flux density
90	BAC			0.0811	T	Transformer core AC flux density (0.5 x Peak-Peak)
91	ALG			119.1	nH/turns <sup>2</sup>	Gapped core effective inductance (Typical)
92	LG			0.41	mm	Core gap length
<b>95</b>	<b>Output Stage</b>					
<b>96</b>	<b>Output 1</b>					
97	VOU1			12.00		Output voltage



98	IOUT1	2.00		2.00		Output current
99	POUT1			24.00		Output power
100	IRMS_SEC1			3.439		Secondary winding RMS current
101	IRIPPLE_COUT1			2.798		Output capacitor ripple current
102	NS1			7		Secondary winding number of turns
103	VDSOFF_DIODE1			51.0		Output rectifier off-time voltage stress (not incl. the parasitic ring)
104	PN_DIODE1			SB380		Suggested output rectifier schottky diode
105	VRRM_DIODE1			80		Output rectifier rated reverse repetitive voltage
106	VF_DIODE1			0.85		Output rectifier rated on-time voltage drop
107	IF_DIODE1			3.0		Output rectifier rated average forward current
<b>109</b>	<b>Output 2</b>					
110	VOUT2	5.00		5.00		Output voltage
111	IOUT2	0.50		0.50		Output current
112	POUT2			2.50		Output power
113	IRMS_SEC2			0.860		Secondary winding RMS current
114	IRIPPLE_COUT2			0.699		Output capacitor ripple current
115	NS2			3		Secondary winding number of turns
116	VDSOFF_DIODE2			21.7		Output rectifier off-time voltage stress (not incl. the parasitic ring)
117	PN_DIODE2			SB240		Suggested output rectifier schottky diode
118	VRRM_DIODE2			40		Output rectifier rated reverse repetitive voltage
119	VF_DIODE2			0.5		Output rectifier rated on-time voltage drop
120	IF_DIODE2			2		Output rectifier rated average forward current
135	POUT_TOTAL			26.5		Total output power
136	NEGATIVE OUTPUT	N/A		N/A		Select the negative output voltage index (Eg. Select 3 if you want the 3rd output to be negative)

## 10 Performance Data

### 10.1 Average Efficiency

#### 10.1.1 Average Efficiency, 115 VAC

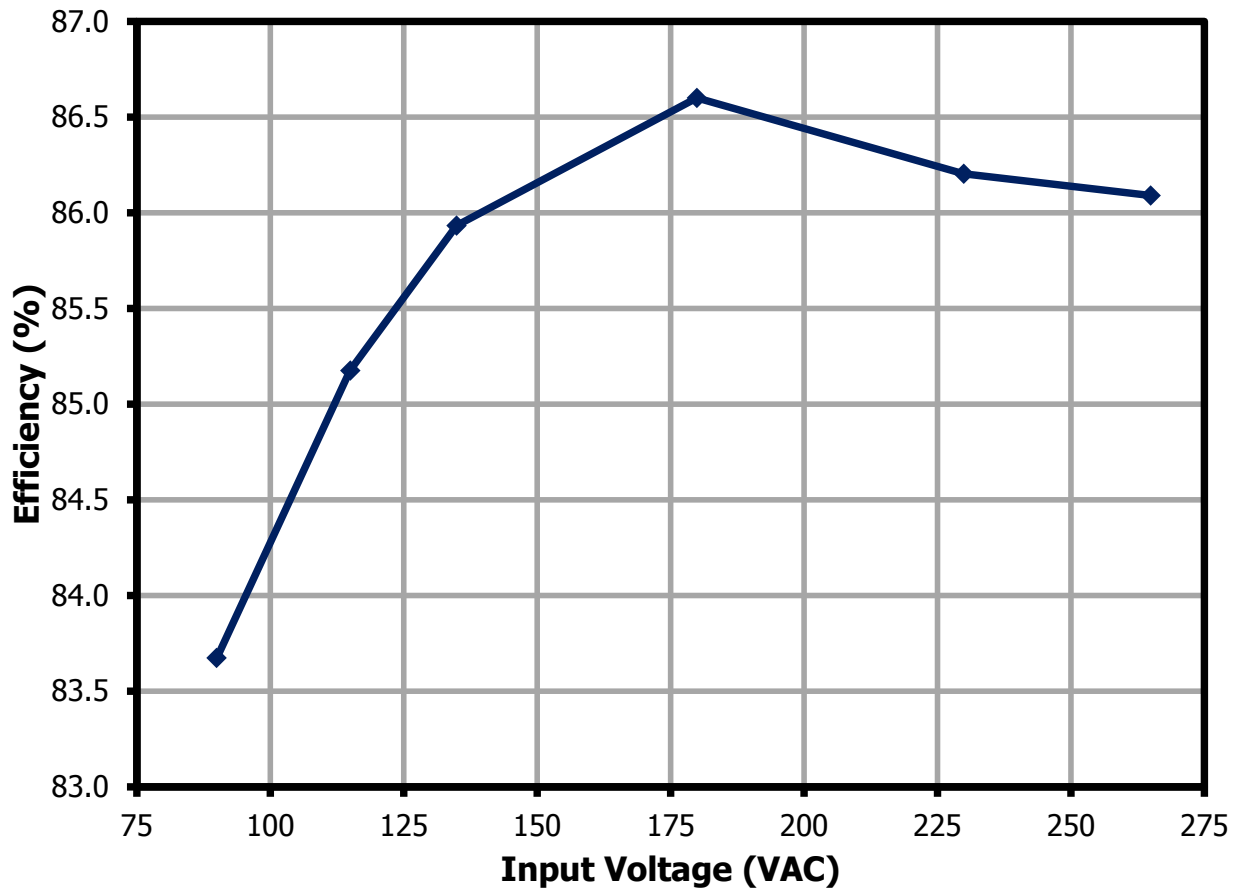
Load	V <sub>IN</sub>	I <sub>IN</sub>	P <sub>IN</sub>	V <sub>OUT1</sub> at PCB	I <sub>OUT1</sub>	P <sub>OUT1</sub>	V <sub>OUT2</sub> at PCB	I <sub>OUT2</sub>	P <sub>OUT2</sub>	Efficiency at PCB
(A)	(V <sub>RMS</sub> )	(mA <sub>RMS</sub> )	(W)	(V <sub>DC</sub> )	(mA <sub>DC</sub> )	(W)	(V <sub>DC</sub> )	(mA <sub>DC</sub> )	(W)	(%)
100%	114.97	546.10	31.25	12.06	1998.50	24.11	5.02	499.58	2.51	85.18
75%	114.98	435.50	23.27	12.07	1498.30	18.08	5.02	374.54	1.88	85.79
50%	114.99	321.60	15.50	12.08	998.60	12.06	5.02	249.54	1.25	85.88
25%	115.00	193.92	7.76	12.08	498.50	6.02	5.02	124.64	0.63	85.71
									<b>Average</b>	<b>85.64</b>

#### 10.1.2 Average Efficiency, 230 VAC

Load	V <sub>IN</sub>	I <sub>IN</sub>	P <sub>IN</sub>	V <sub>OUT1</sub> at PCB	I <sub>OUT1</sub>	P <sub>OUT1</sub>	V <sub>OUT2</sub> at PCB	I <sub>OUT2</sub>	P <sub>OUT2</sub>	Efficiency at PCB
(A)	(V <sub>RMS</sub> )	(mA <sub>RMS</sub> )	(W)	(V <sub>DC</sub> )	(mA <sub>DC</sub> )	(W)	(V <sub>DC</sub> )	(mA <sub>DC</sub> )	(W)	(%)
100%	229.90	359.20	30.84	12.04	1998.50	24.07	5.03	499.56	2.51	86.17
75%	229.91	286.30	23.11	12.05	1498.30	18.05	5.03	374.53	1.88	86.25
50%	229.91	270.60	21.53	12.05	1398.30	16.85	5.03	349.53	1.76	86.41
25%	229.91	208.30	15.40	12.05	998.60	12.04	5.03	249.52	1.25	86.30
									<b>Average</b>	<b>86.19</b>

## 10.2 Full Load Efficiency vs. Line

Test Condition: Soak for 15 minutes for each line.



**Figure 7** – Efficiency vs. Input Voltage.

10.3 **Efficiency vs. Load**

Test Condition: Soak for 15 minutes each line, and 5 minutes for each load.

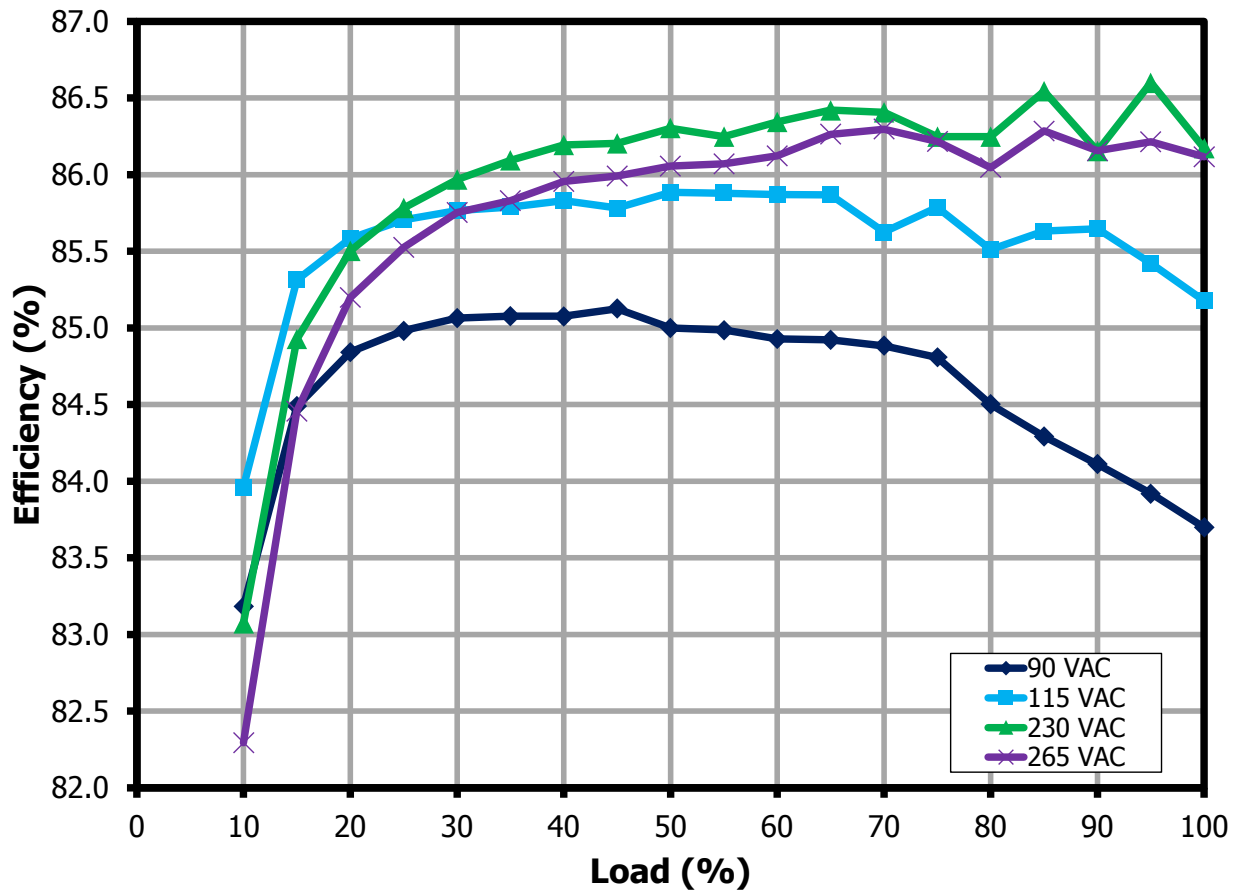
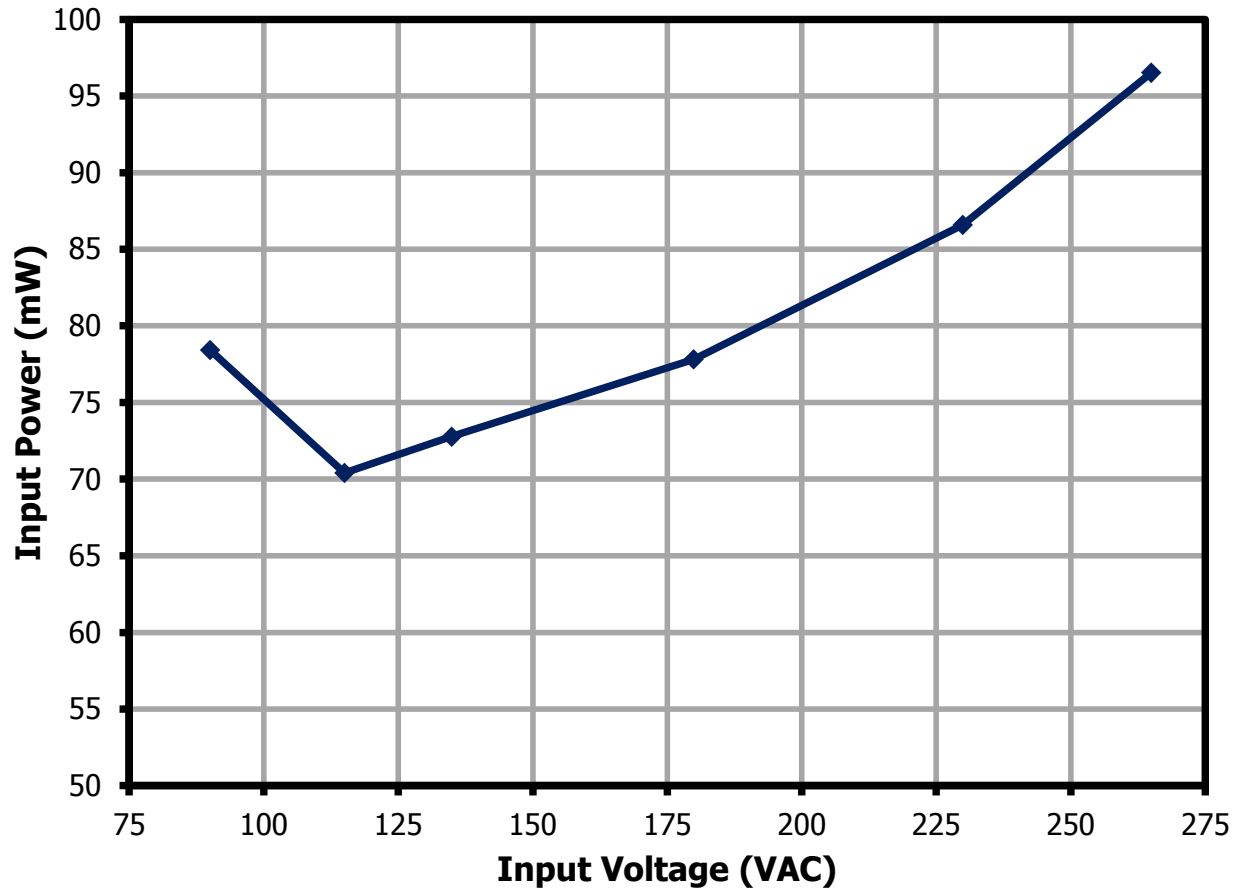


Figure 8 – Efficiency vs. Percentage Load.

#### 10.4 **No-Load Input Power**

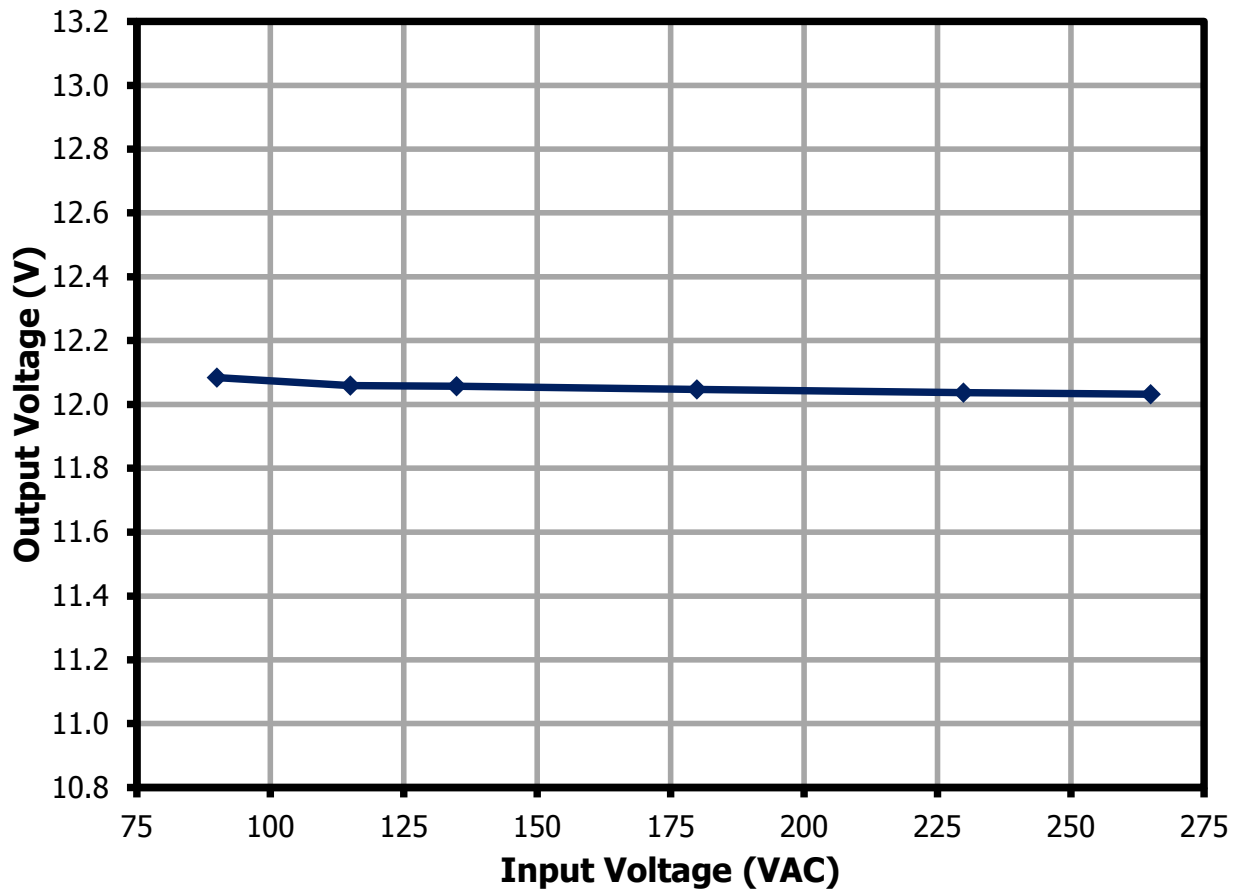
Test Condition: Soak for 15 minutes each line and 1 minute integration time.



**Figure 9** – No-Load Input Power vs. Line at Room Temperature.

10.5 **Line Regulation**

Test Condition: Soak for 15 minutes for each line.



**Figure 10** – 12 V Output Voltage vs. Line Voltage.

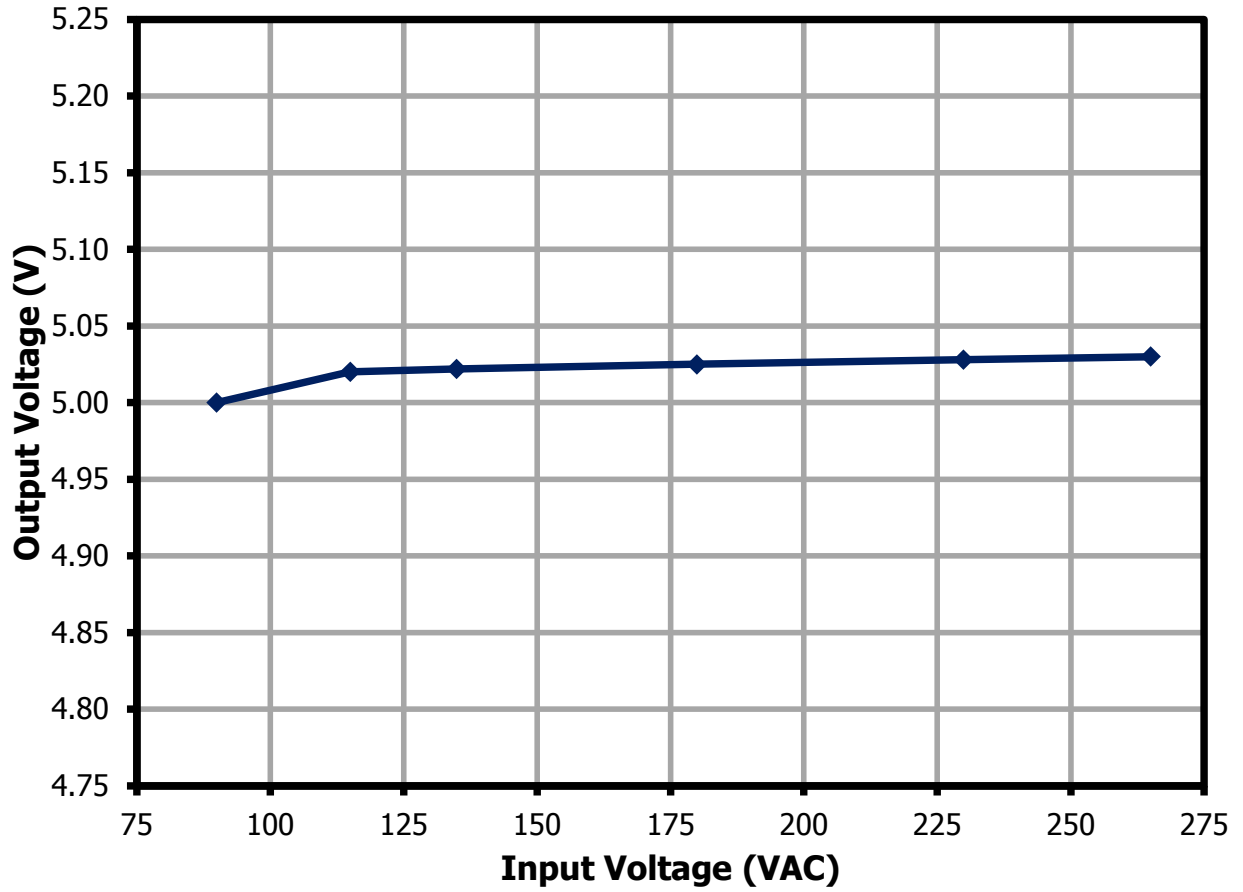


Figure 11 – 5 V Output Voltage vs. Line Voltage.



### 10.6 Load Regulation

Test Condition: Soak for 15 minutes each line, and 5 minutes for each load.

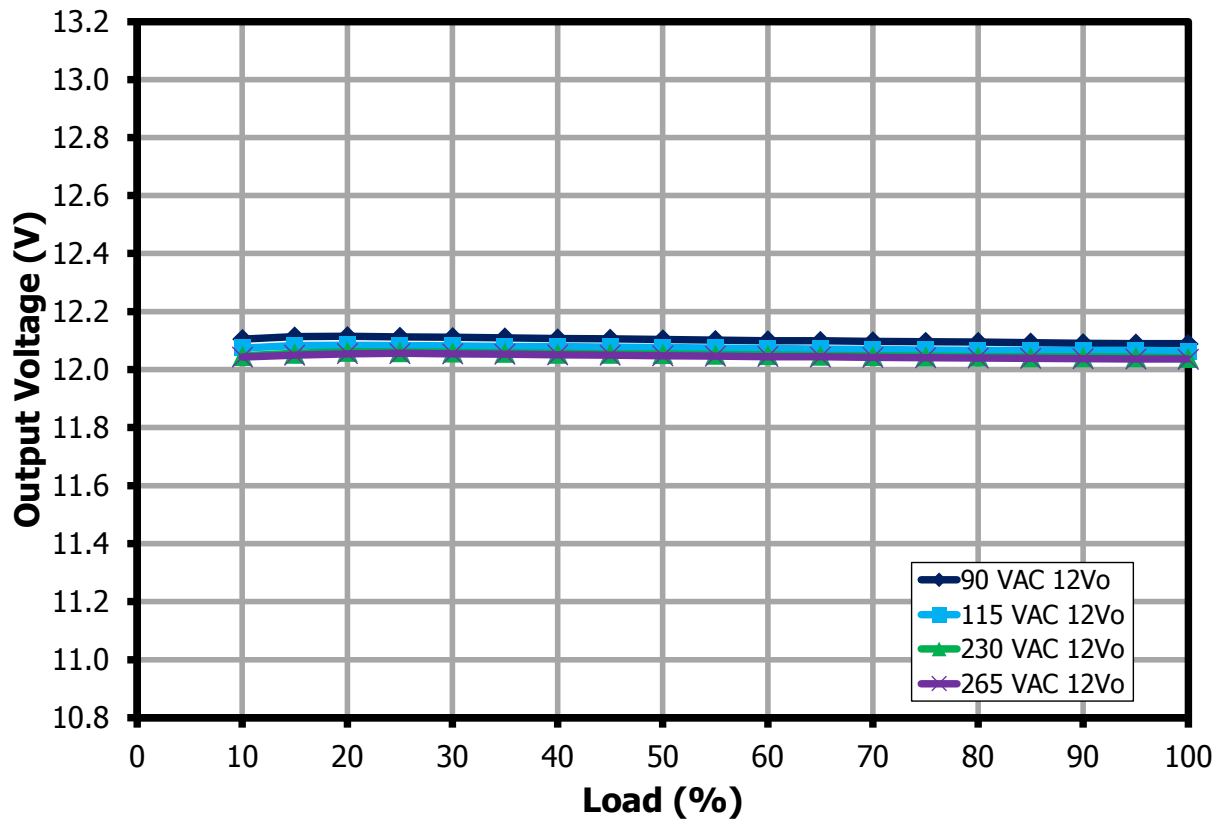


Figure 12 – 12 V Output Voltage vs. Percent Load.

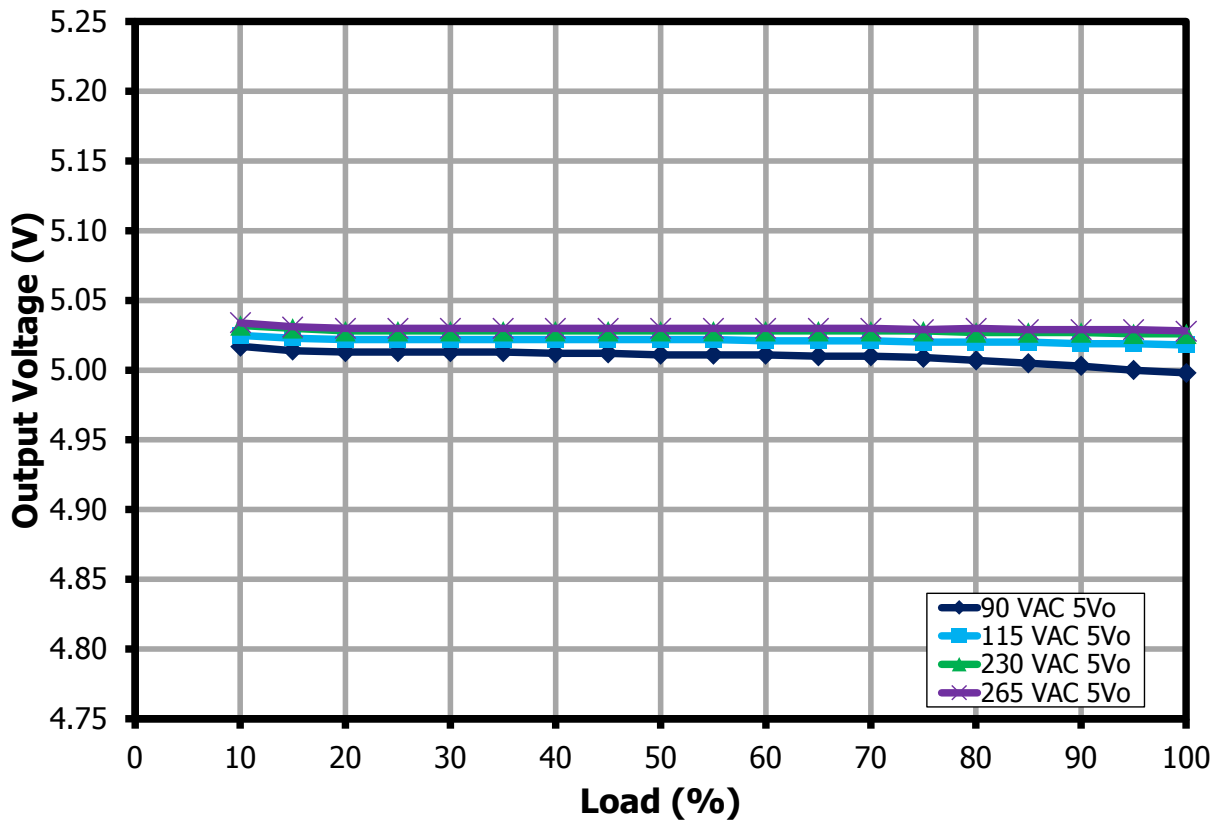


Figure 13 – 5 V Output Voltage vs. Percent Load.

## 10.7 Cross Regulation

### 10.7.1 Cross Regulation with 12 V at Minimum Load and Varying 5 V Load

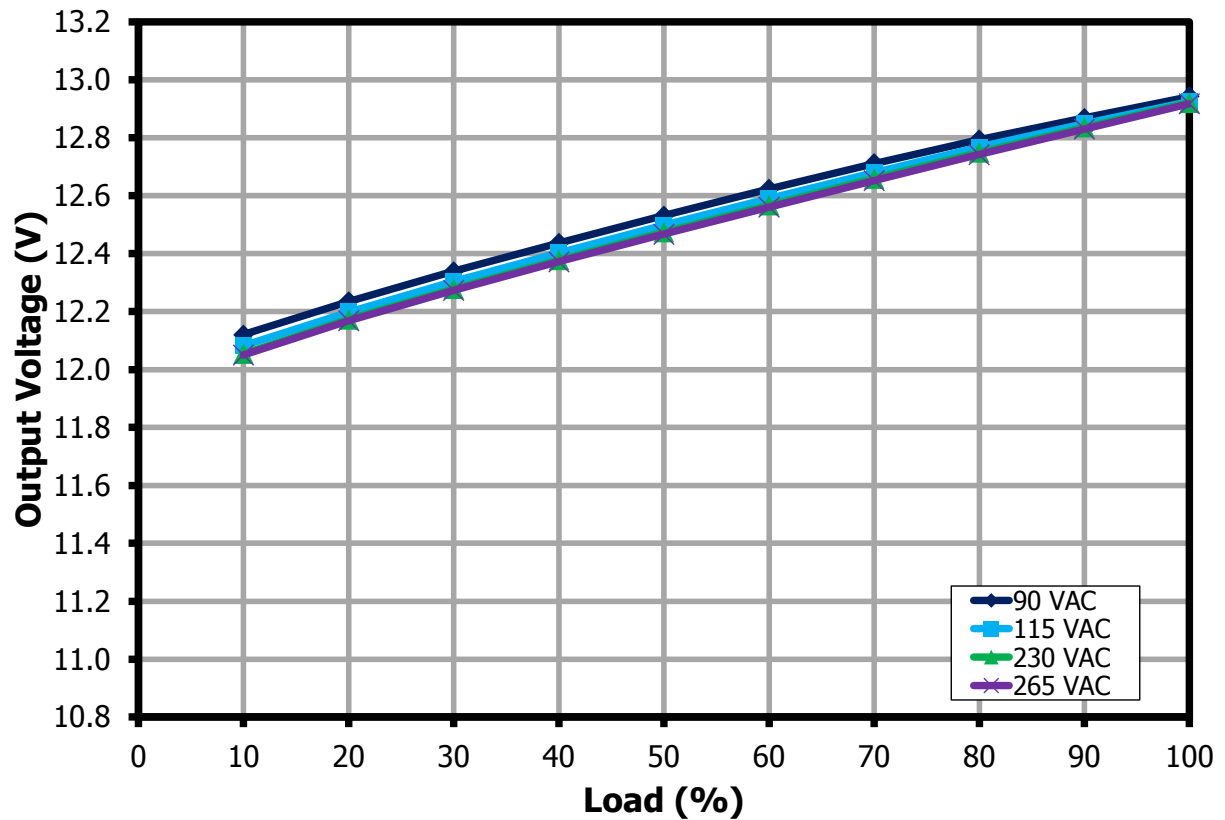


Figure 14 – 12 V Output Voltage vs. Percent Load.

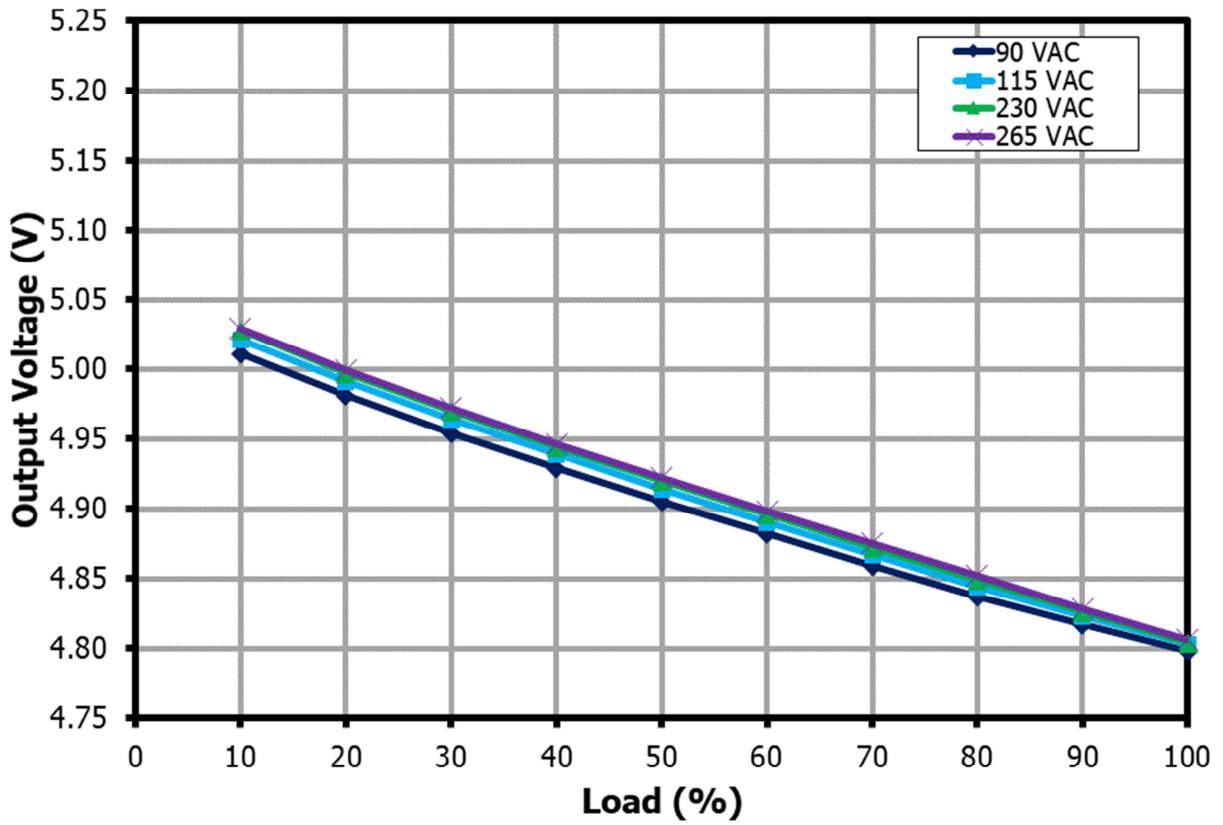


Figure 15 – 5 V Output Voltage vs. Percent Load.

## 10.7.2 Cross Regulation with 12 V at Full Load and Varying 5 V Load

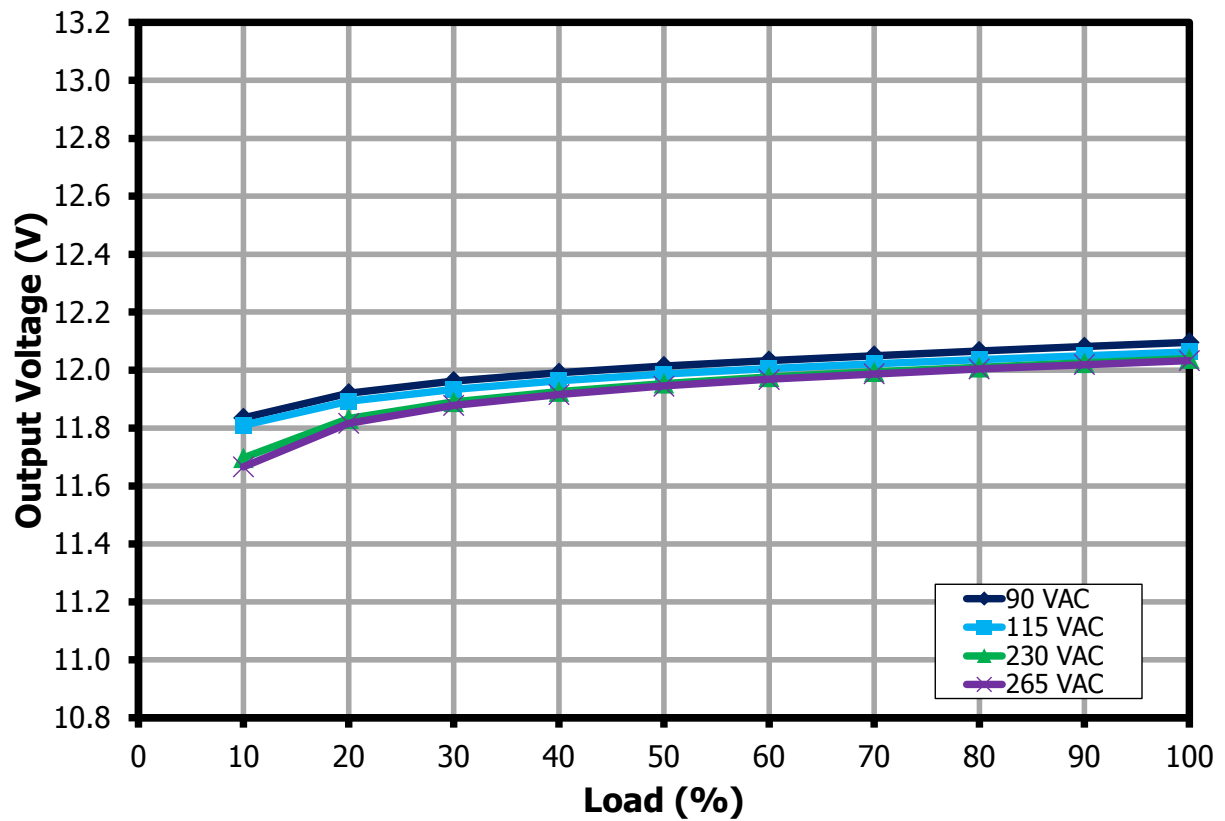


Figure 16 – 12 V Output Voltage vs. Percent Load.

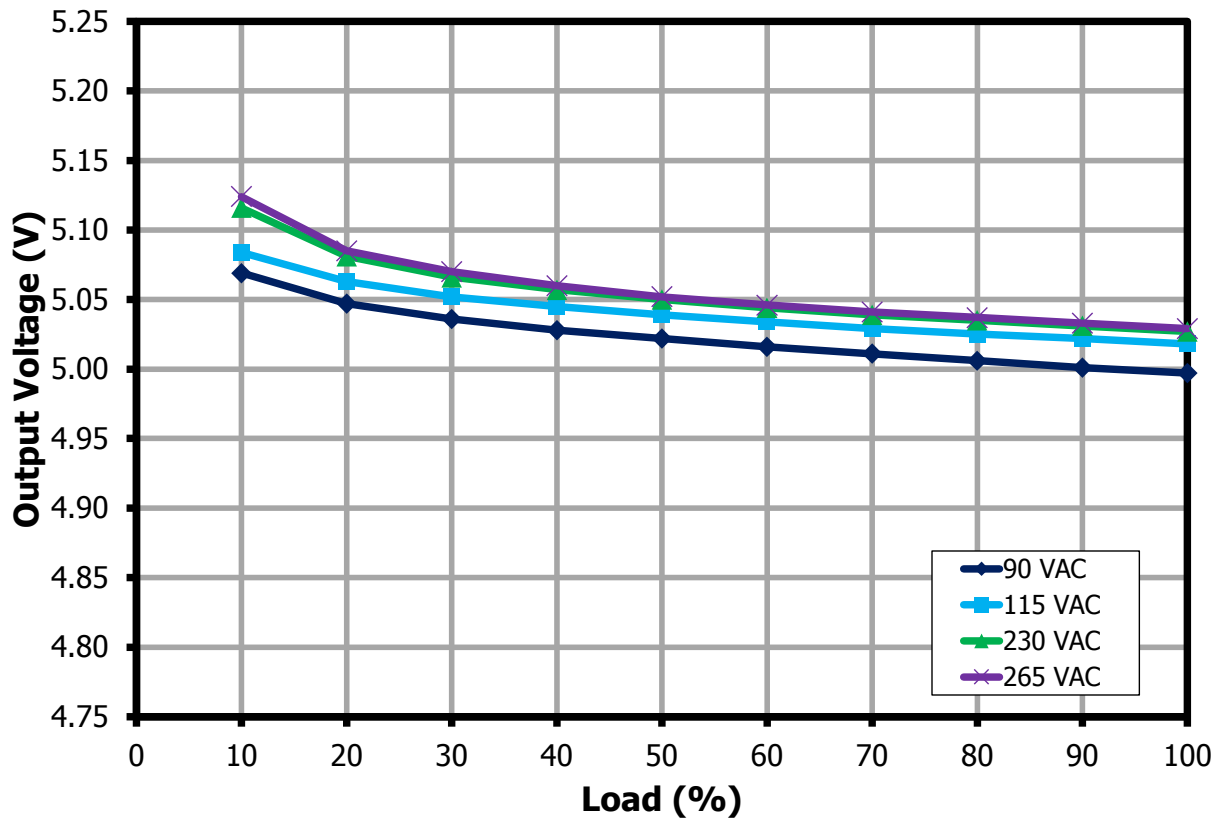
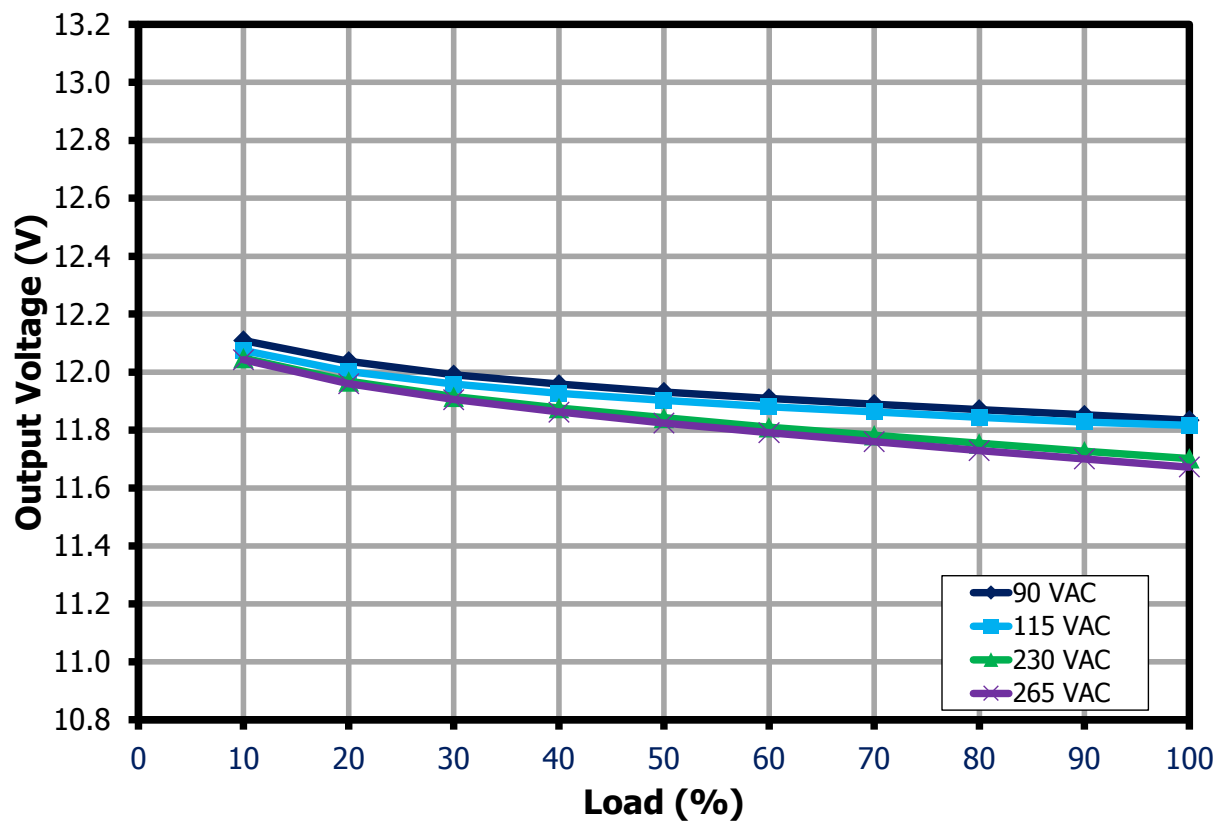


Figure 17 – 5 V Output Voltage vs. Percent Load.

## 10.7.3 Cross Regulation with 5 V at Minimum Load and Varying 12 V Load



**Figure 18** – 12 V Output Voltage vs. Percent Load.

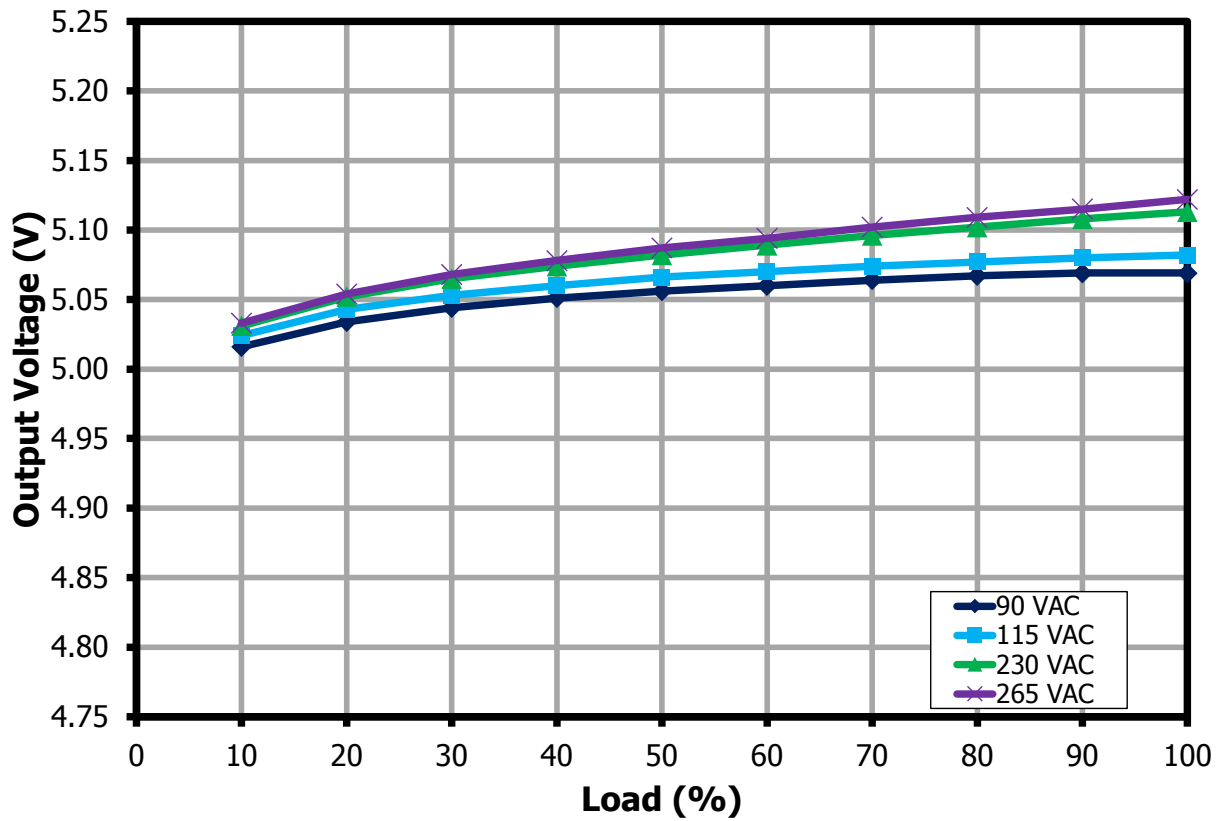


Figure 19 – 5 V Output Voltage vs. Percent Load.



## 10.7.4 Cross Regulation with 5 V at Full Load and Varying 12 V Load

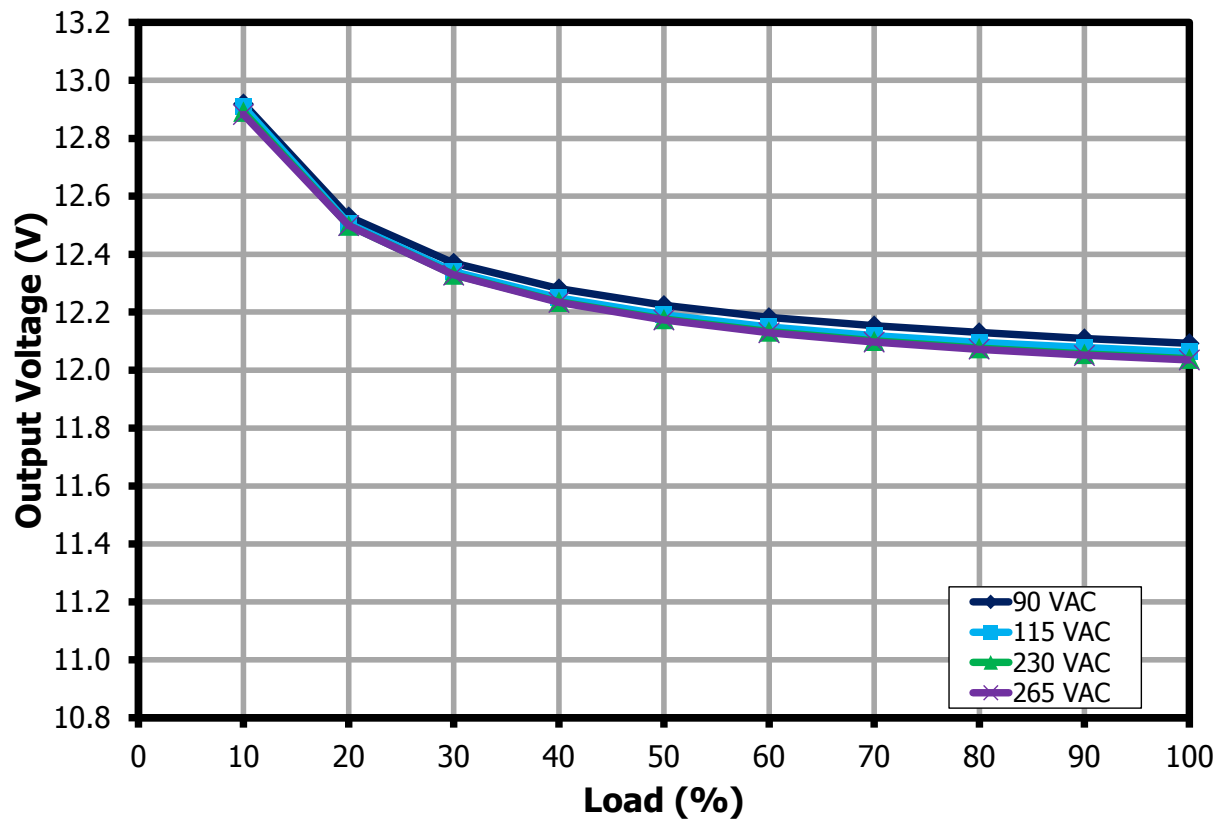


Figure 20 – 12 V Output Voltage vs. Percent Load.

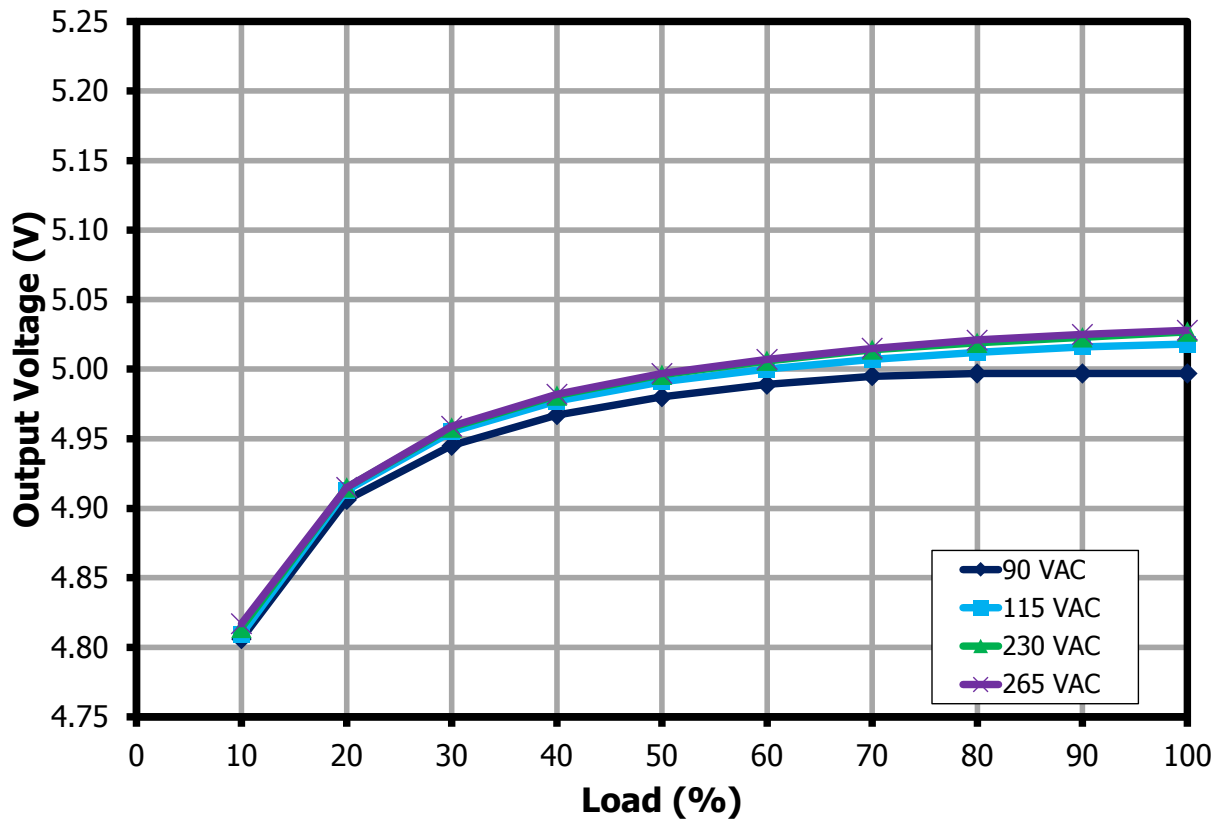


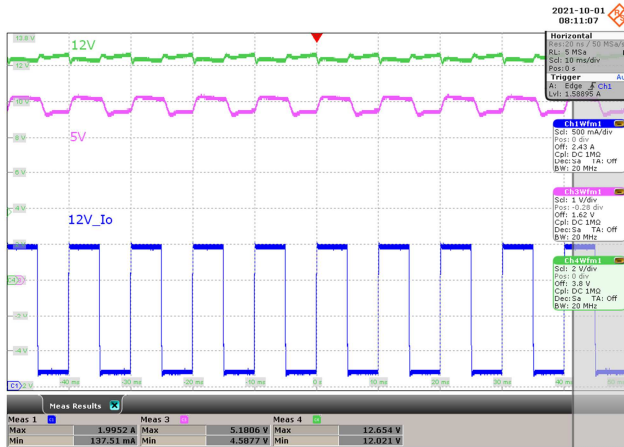
Figure 21 – 5 V Output Voltage vs. Percent Load.

## 11 Waveforms

### 11.1 Load Transient Response

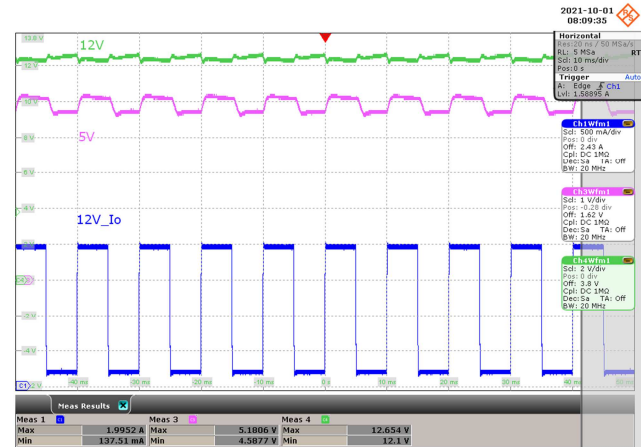
Test Condition: Dynamic load frequency = 100 Hz, Duty cycle = 50 %  
Slew Rate = 0.8 A /  $\mu$ s

#### 11.1.1 12 V Transient 10% - 100% Load Change (5 V, 100% Load)



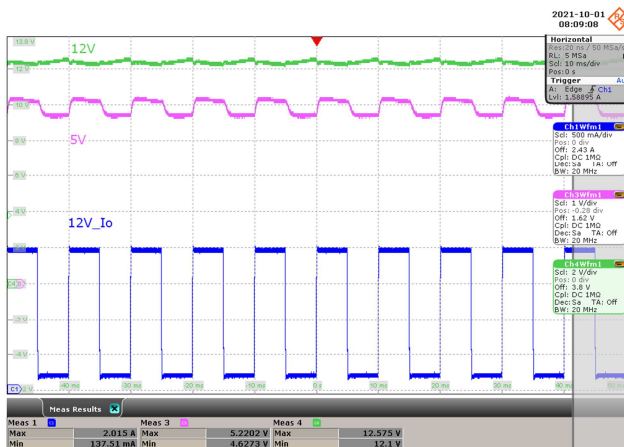
**Figure 22** – 90 VAC 60 Hz.

CH1:  $I_{12V\_OUT}$ , 500 mA / div., 10 ms / div.  
CH3:  $V_{5V\_OUT}$ , 1 V / div., 10 ms / div.  
CH4:  $V_{12V\_OUT}$ , 2 V / div., 10 ms / div.  
12 V<sub>OUT</sub>:  $V_{MAX}$ : 12.654 V,  $V_{MIN}$ : 12.021 V.  
5 V<sub>OUT</sub>:  $V_{MAX}$ : 5.1806 V,  $V_{MIN}$ : 4.5877 V.



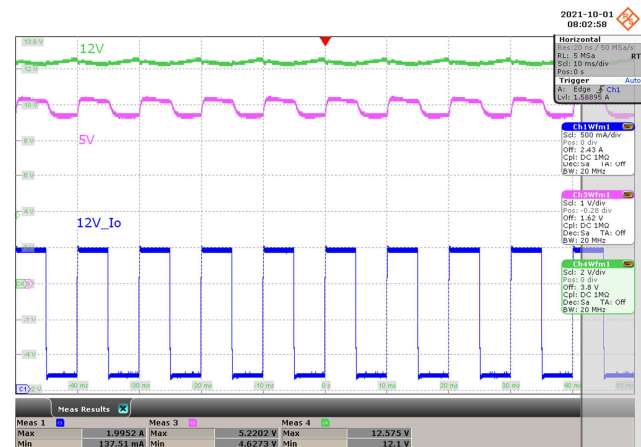
**Figure 23** – 115 VAC 60 Hz.

CH1:  $I_{12V\_OUT}$ , 500 mA / div., 10 ms / div.  
CH3:  $V_{5V\_OUT}$ , 1 V / div., 10 ms / div.  
CH4:  $V_{12V\_OUT}$ , 2 V / div., 10 ms / div.  
12 V<sub>OUT</sub>:  $V_{MAX}$ : 12.654 V,  $V_{MIN}$ : 12.1 V.  
5 V<sub>OUT</sub>:  $V_{MAX}$ : 5.1806 V,  $V_{MIN}$ : 4.5877 V.



**Figure 24** – 230 VAC 50 Hz.

CH1:  $I_{12V\_OUT}$ , 500 mA / div., 10 ms / div.  
CH3:  $V_{5V\_OUT}$ , 1 V / div., 10 ms / div.  
CH4:  $V_{12V\_OUT}$ , 2 V / div., 10 ms / div.  
12 V<sub>OUT</sub>:  $V_{MAX}$ : 12.575 V,  $V_{MIN}$ : 12.1 V.  
5 V<sub>OUT</sub>:  $V_{MAX}$ : 5.2202 V,  $V_{MIN}$ : 4.6273 V.



**Figure 25** – 265 VAC 50 Hz.

CH1:  $I_{12V\_OUT}$ , 500 mA / div., 10 ms / div.  
CH3:  $V_{5V\_OUT}$ , 1 V / div., 10 ms / div.  
CH4:  $V_{12V\_OUT}$ , 2 V / div., 10 ms / div.  
12 V<sub>OUT</sub>:  $V_{MAX}$ : 12.575 V,  $V_{MIN}$ : 12.1 V.  
5 V<sub>OUT</sub>:  $V_{MAX}$ : 5.2202 V,  $V_{MIN}$ : 4.6273 V.

## 11.1.2 12 V Transient 50% - 100% Load Change (5 V, 100% Load)

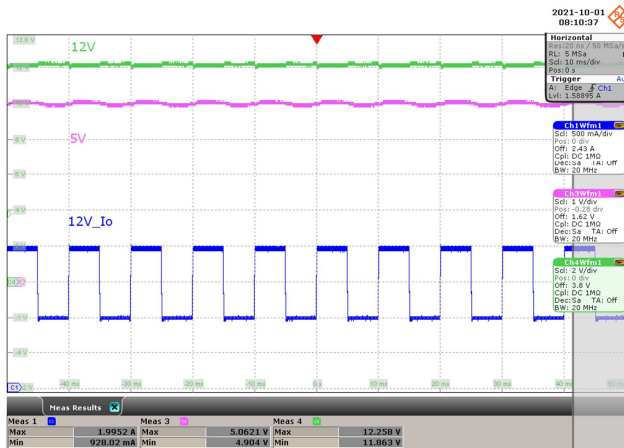


Figure 26 – 90 VAC 60 Hz.

CH1:  $I_{12V\_OUT}$ , 500 mA / div., 10 ms / div.  
 CH3:  $V_{5V\_OUT}$ , 1 V / div., 10 ms / div.  
 CH4:  $V_{12V\_OUT}$ , 2 V / div., 10 ms / div.  
 12 V<sub>OUT</sub>:  $V_{MAX}$ : 12.258 V,  $V_{MIN}$ : 11.863 V.  
 5 V<sub>OUT</sub>:  $V_{MAX}$ : 5.0621 V,  $V_{MIN}$ : 4.904 V.

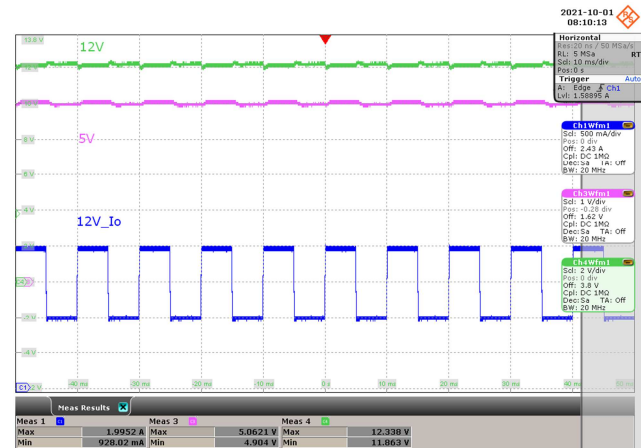


Figure 27 – 115 VAC 60 Hz.

CH1:  $I_{12V\_OUT}$ , 500 mA / div., 10 ms / div.  
 CH3:  $V_{5V\_OUT}$ , 1 V / div., 10 ms / div.  
 CH4:  $V_{12V\_OUT}$ , 2 V / div., 10 ms / div.  
 12 V<sub>OUT</sub>:  $V_{MAX}$ : 12.338 V,  $V_{MIN}$ : 11.863 V.  
 5 V<sub>OUT</sub>:  $V_{MAX}$ : 5.0621 V,  $V_{MIN}$ : 4.904 V.

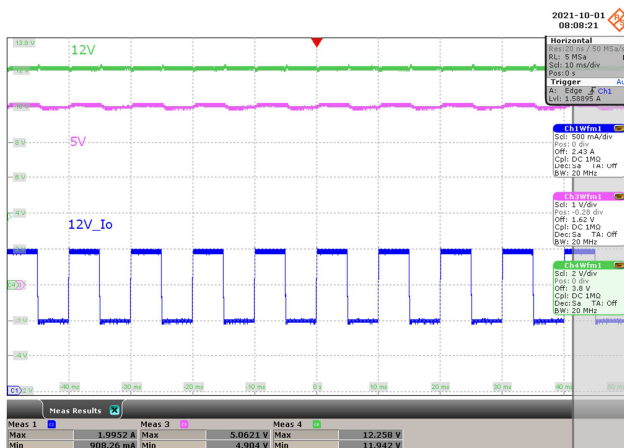


Figure 28 – 230 VAC 50 Hz.

CH1:  $I_{12V\_OUT}$ , 500 mA / div., 10 ms / div.  
 CH3:  $V_{5V\_OUT}$ , 1 V / div., 10 ms / div.  
 CH4:  $V_{12V\_OUT}$ , 2 V / div., 10 ms / div.  
 12 V<sub>OUT</sub>:  $V_{MAX}$ : 12.258 V,  $V_{MIN}$ : 11.942 V.  
 5 V<sub>OUT</sub>:  $V_{MAX}$ : 5.0621 V,  $V_{MIN}$ : 4.904 V.

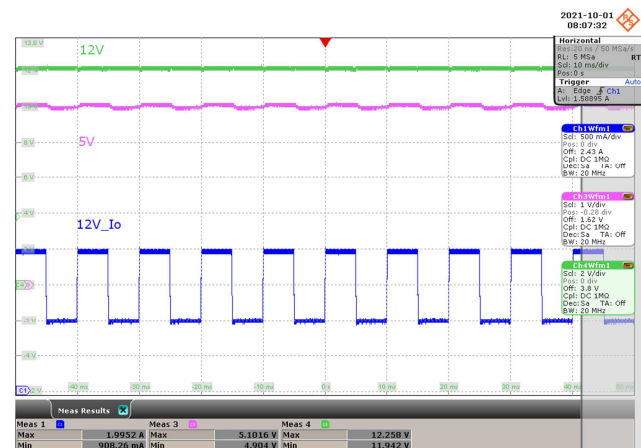


Figure 29 – 265 VAC 50 Hz.

CH1:  $I_{12V\_OUT}$ , 500 mA / div., 10 ms / div.  
 CH3:  $V_{5V\_OUT}$ , 1 V / div., 10 ms / div.  
 CH4:  $V_{12V\_OUT}$ , 2 V / div., 10 ms / div.  
 12 V<sub>OUT</sub>:  $V_{MAX}$ : 12.258 V,  $V_{MIN}$ : 11.942 V.  
 5 V<sub>OUT</sub>:  $V_{MAX}$ : 5.1016 V,  $V_{MIN}$ : 4.904 V.

## 11.1.3 12 V Transient 10% - 100% Load Change (5 V, 10% Load)

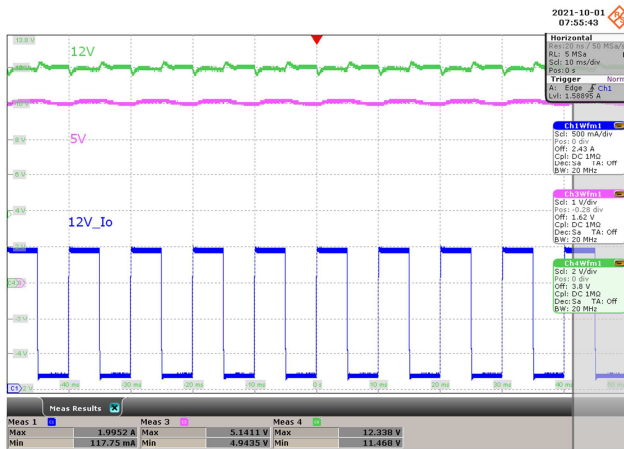


Figure 30 – 90 VAC 60 Hz.

CH1:  $I_{12V\_OUT}$ , 500 mA / div., 10 ms / div.  
 CH3:  $V_{5V\_OUT}$ , 1 V / div., 10 ms / div.  
 CH4:  $V_{12V\_OUT}$ , 2 V / div., 10 ms / div.  
 12 V<sub>OUT</sub>:  $V_{MAX}$ : 12.338 V,  $V_{MIN}$ : 11.468 V.  
 5 V<sub>OUT</sub>:  $V_{MAX}$ : 5.1411 V,  $V_{MIN}$ : 4.9435 V.

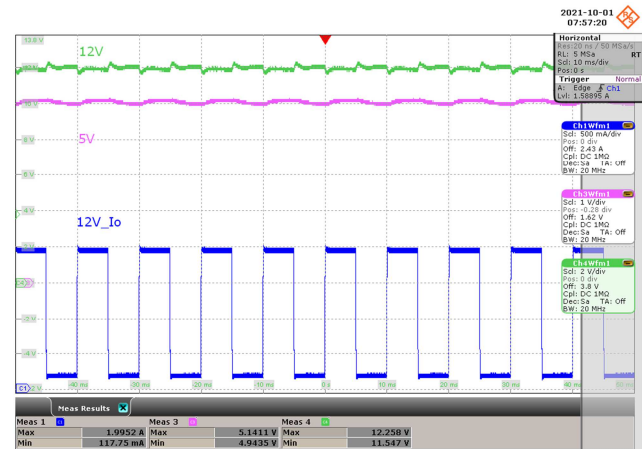


Figure 31 – 115 VAC 60 Hz.

CH1:  $I_{12V\_OUT}$ , 500 mA / div., 10 ms / div.  
 CH3:  $V_{5V\_OUT}$ , 1 V / div., 10 ms / div.  
 CH4:  $V_{12V\_OUT}$ , 2 V / div., 10 ms / div.  
 12 V<sub>OUT</sub>:  $V_{MAX}$ : 12.258 V,  $V_{MIN}$ : 11.547 V.  
 5 V<sub>OUT</sub>:  $V_{MAX}$ : 5.1411 V,  $V_{MIN}$ : 4.9435 V.

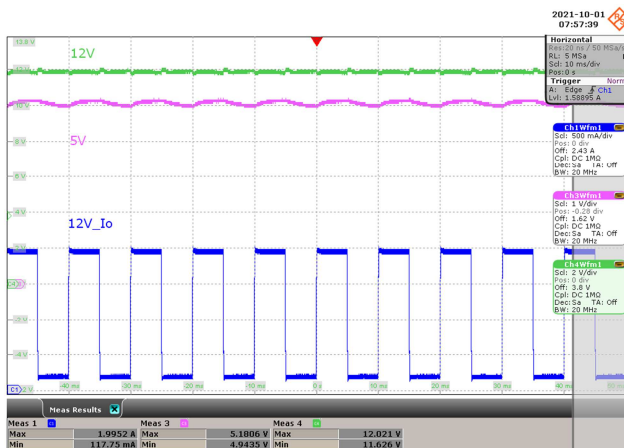


Figure 32 – 230 VAC 50 Hz.

CH1:  $I_{12V\_OUT}$ , 500 mA / div., 10 ms / div.  
 CH3:  $V_{5V\_OUT}$ , 1 V / div., 10 ms / div.  
 CH4:  $V_{12V\_OUT}$ , 2 V / div., 10 ms / div.  
 12 V<sub>OUT</sub>:  $V_{MAX}$ : 12.021 V,  $V_{MIN}$ : 11.626 V.  
 5 V<sub>OUT</sub>:  $V_{MAX}$ : 5.1806 V,  $V_{MIN}$ : 4.9435 V.

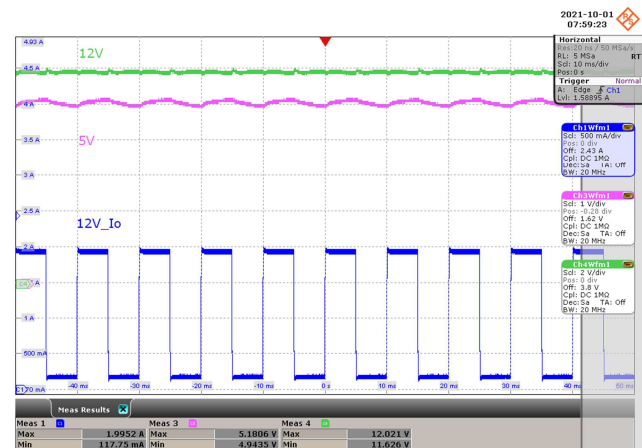


Figure 33 – 265 VAC 50 Hz.

CH1:  $I_{12V\_OUT}$ , 500 mA / div., 10 ms / div.  
 CH3:  $V_{5V\_OUT}$ , 1 V / div., 10 ms / div.  
 CH4:  $V_{12V\_OUT}$ , 2 V / div., 10 ms / div.  
 12 V<sub>OUT</sub>:  $V_{MAX}$ : 12.021 V,  $V_{MIN}$ : 11.626 V.  
 5 V<sub>OUT</sub>:  $V_{MAX}$ : 5.1806 V,  $V_{MIN}$ : 4.9435 V.

## 11.1.4 12 V Transient 50% - 100% Load Change (5 V, 10% Load)

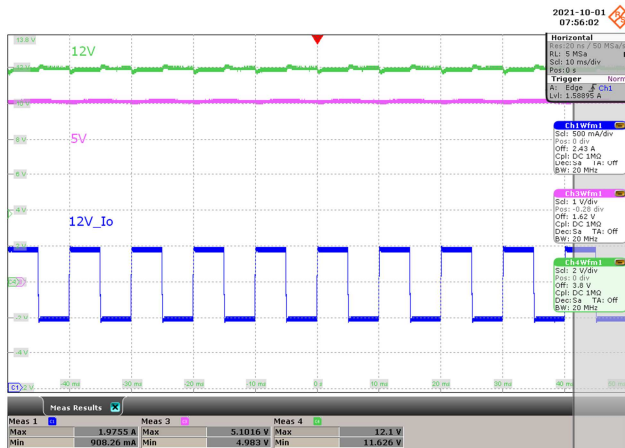


Figure 34 – 90 VAC 60 Hz.

CH1:  $I_{12V\_OUT}$ , 500 mA / div., 10 ms / div.  
 CH3:  $V_{5V\_OUT}$ , 1 V / div., 10 ms / div.  
 CH4:  $V_{12V\_OUT}$ , 2 V / div., 10 ms / div.  
 12 V<sub>OUT</sub>:  $V_{MAX}$ : 12.1 V,  $V_{MIN}$ : 11.626 V.  
 5 V<sub>OUT</sub>:  $V_{MAX}$ : 5.1016 V,  $V_{MIN}$ : 4.983 V.

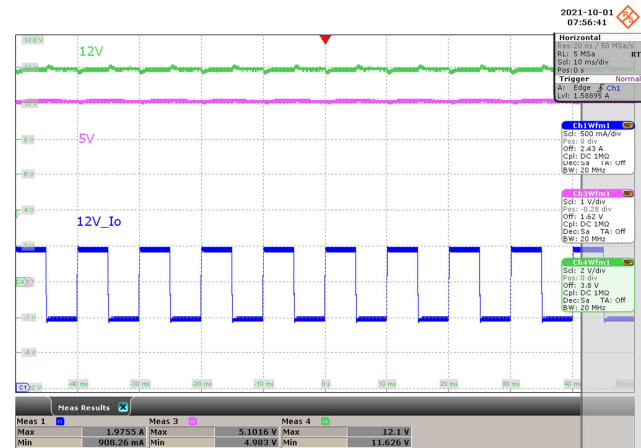


Figure 35 – 115 VAC 60 Hz.

CH1:  $I_{12V\_OUT}$ , 500 mA / div., 10 ms / div.  
 CH3:  $V_{5V\_OUT}$ , 1 V / div., 10 ms / div.  
 CH4:  $V_{12V\_OUT}$ , 2 V / div., 10 ms / div.  
 12 V<sub>OUT</sub>:  $V_{MAX}$ : 12.1 V,  $V_{MIN}$ : 11.626 V.  
 5 V<sub>OUT</sub>:  $V_{MAX}$ : 5.1016 V,  $V_{MIN}$ : 4.983 V.

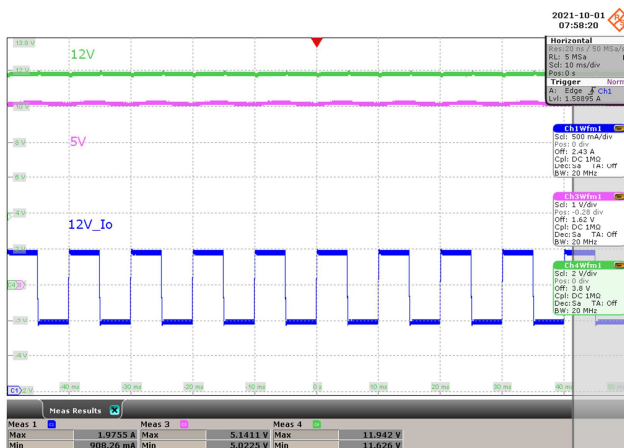


Figure 36 – 230 VAC 50 Hz.

CH1:  $I_{12V\_OUT}$ , 500 mA / div., 10 ms / div.  
 CH3:  $V_{5V\_OUT}$ , 1 V / div., 10 ms / div.  
 CH4:  $V_{12V\_OUT}$ , 2 V / div., 10 ms / div.  
 12 V<sub>OUT</sub>:  $V_{MAX}$ : 11.942 V,  $V_{MIN}$ : 11.626 V.  
 5 V<sub>OUT</sub>:  $V_{MAX}$ : 5.1411 V,  $V_{MIN}$ : 5.0225 V.

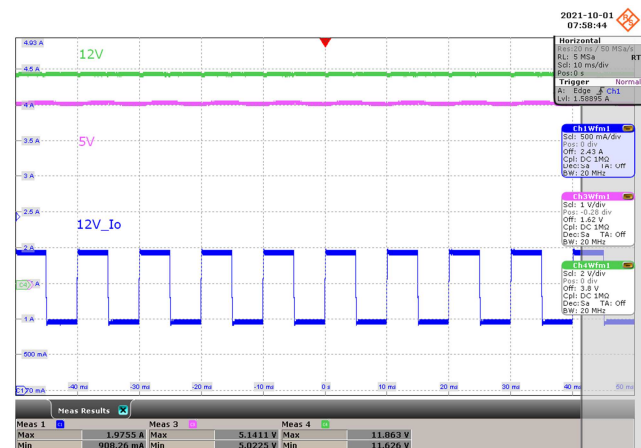


Figure 37 – 265 VAC 50 Hz.

CH1:  $I_{12V\_OUT}$ , 500 mA / div., 10 ms / div.  
 CH3:  $V_{5V\_OUT}$ , 1 V / div., 10 ms / div.  
 CH4:  $V_{12V\_OUT}$ , 2 V / div., 10 ms / div.  
 12 V<sub>OUT</sub>:  $V_{MAX}$ : 11.863 V,  $V_{MIN}$ : 11.626 V.  
 5 V<sub>OUT</sub>:  $V_{MAX}$ : 5.1411 V,  $V_{MIN}$ : 5.0225 V.



## 11.1.5 5 V Transient 10% - 100% Load Change (12 V, 100% Load)

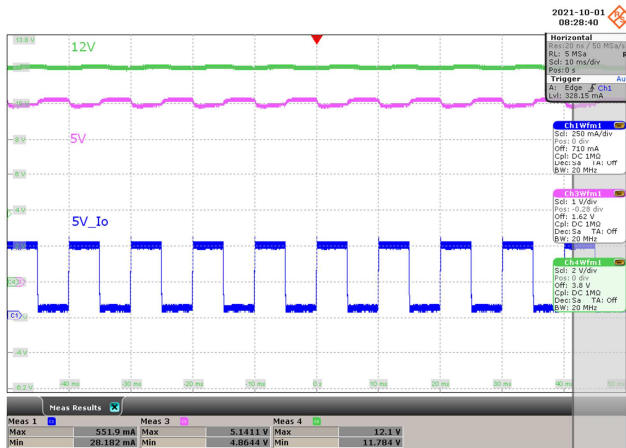


Figure 38 – 90 VAC 60 Hz.

CH1:  $I_{5V\_OUT}$ , 250 mA / div., 10 ms / div.  
 CH3:  $V_{5V\_OUT}$ , 1 V / div., 10 ms / div.  
 CH4:  $V_{12V\_OUT}$ , 2 V / div., 10 ms / div.  
 12 V<sub>OUT</sub>:  $V_{MAX}$ : 12.1 V,  $V_{MIN}$ : 11.784 V.  
 5 V<sub>OUT</sub>:  $V_{MAX}$ : 5.1411 V,  $V_{MIN}$ : 4.8644 V.

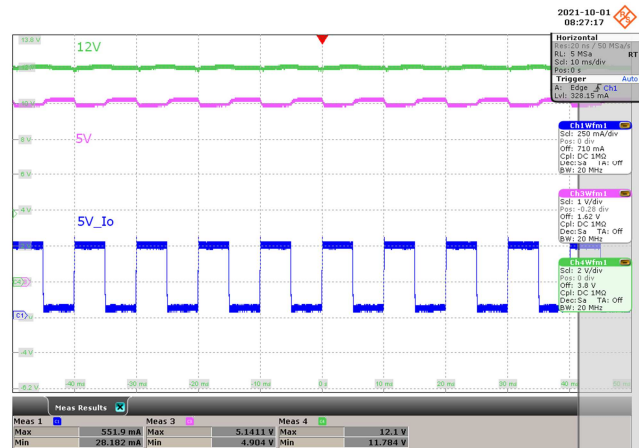


Figure 39 – 115 VAC 60 Hz.

CH1:  $I_{5V\_OUT}$ , 250 mA / div., 10 ms / div.  
 CH3:  $V_{5V\_OUT}$ , 1 V / div., 10 ms / div.  
 CH4:  $V_{12V\_OUT}$ , 2 V / div., 10 ms / div.  
 12 V<sub>OUT</sub>:  $V_{MAX}$ : 12.1 V,  $V_{MIN}$ : 11.784 V.  
 5 V<sub>OUT</sub>:  $V_{MAX}$ : 5.1411 V,  $V_{MIN}$ : 4.904 V.

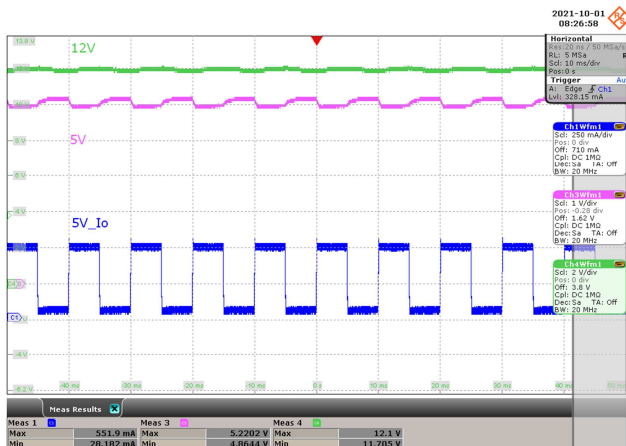


Figure 40 – 230 VAC 50 Hz.

CH1:  $I_{5V\_OUT}$ , 250 mA / div., 10 ms / div.  
 CH3:  $V_{5V\_OUT}$ , 1 V / div., 10 ms / div.  
 CH4:  $V_{12V\_OUT}$ , 2 V / div., 10 ms / div.  
 12 V<sub>OUT</sub>:  $V_{MAX}$ : 12.1 V,  $V_{MIN}$ : 11.705 V.  
 5 V<sub>OUT</sub>:  $V_{MAX}$ : 5.2202 V,  $V_{MIN}$ : 4.8644 V.

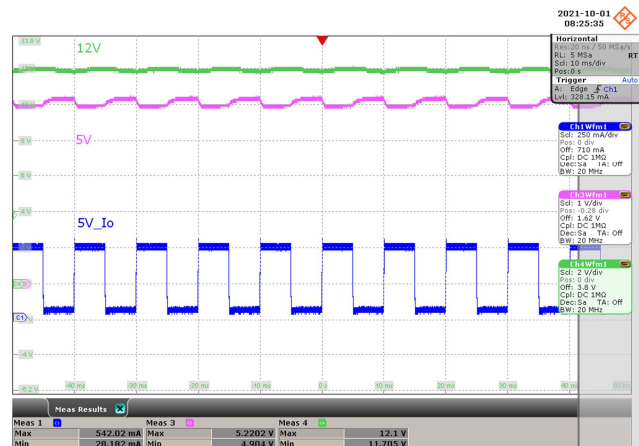


Figure 41 – 265 VAC 50 Hz.

CH1:  $I_{5V\_OUT}$ , 250 mA / div., 10 ms / div.  
 CH3:  $V_{5V\_OUT}$ , 1 V / div., 10 ms / div.  
 CH4:  $V_{12V\_OUT}$ , 2 V / div., 10 ms / div.  
 12 V<sub>OUT</sub>:  $V_{MAX}$ : 12.1 V,  $V_{MIN}$ : 11.705 V.  
 5 V<sub>OUT</sub>:  $V_{MAX}$ : 5.2202 V,  $V_{MIN}$ : 4.904 V.

## 11.1.6 5 V Transient 50% - 100% Load Change (12 V, 100% Load)

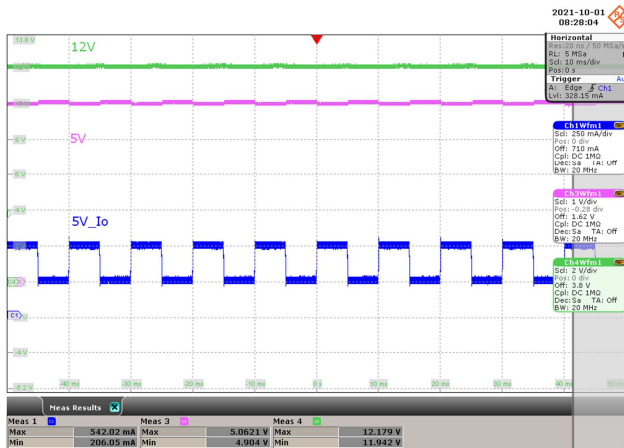


Figure 42 – 90 VAC 60 Hz.

CH1:  $I_{5V\_OUT}$ , 250 mA / div., 10 ms / div.  
 CH3:  $V_{5V\_OUT}$ , 1 V / div., 10 ms / div.  
 CH4:  $V_{12V\_OUT}$ , 2 V / div., 10 ms / div.  
 12 V<sub>OUT</sub>:  $V_{MAX}$ : 12.179 V,  $V_{MIN}$ : 11.942 V.  
 5 V<sub>OUT</sub>:  $V_{MAX}$ : 5.0621 V,  $V_{MIN}$ : 4.904 V.

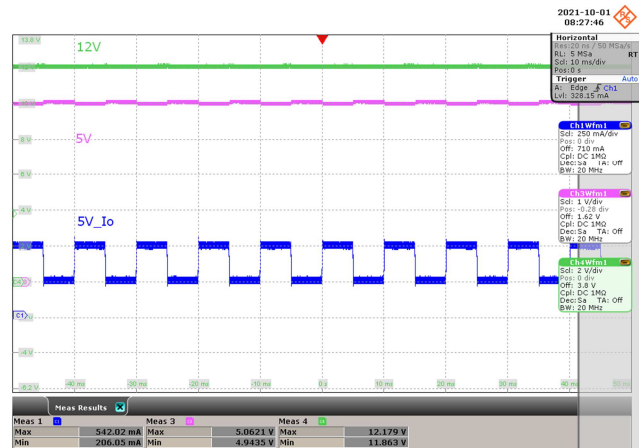


Figure 43 – 115 VAC 60 Hz.

CH1:  $I_{5V\_OUT}$ , 250 mA / div., 10 ms / div.  
 CH3:  $V_{5V\_OUT}$ , 1 V / div., 10 ms / div.  
 CH4:  $V_{12V\_OUT}$ , 2 V / div., 10 ms / div.  
 12 V<sub>OUT</sub>:  $V_{MAX}$ : 12.179 V,  $V_{MIN}$ : 11.863 V.  
 5 V<sub>OUT</sub>:  $V_{MAX}$ : 5.0621 V,  $V_{MIN}$ : 4.9435 V.

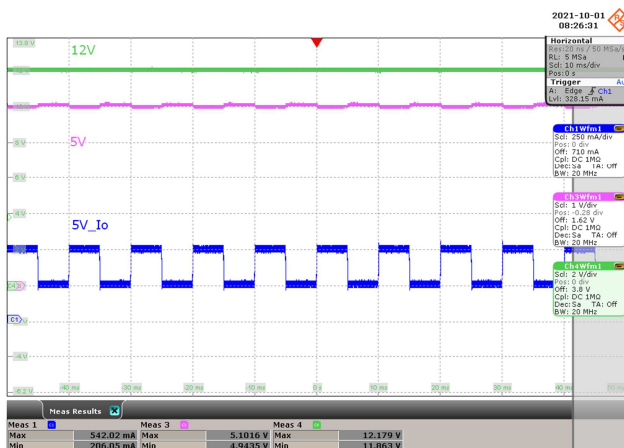


Figure 44 – 230 VAC 50 Hz.

CH1:  $I_{5V\_OUT}$ , 250 mA / div., 10 ms / div.  
 CH3:  $V_{5V\_OUT}$ , 1 V / div., 10 ms / div.  
 CH4:  $V_{12V\_OUT}$ , 2 V / div., 10 ms / div.  
 12 V<sub>OUT</sub>:  $V_{MAX}$ : 12.179 V,  $V_{MIN}$ : 11.863 V.  
 5 V<sub>OUT</sub>:  $V_{MAX}$ : 5.1016 V,  $V_{MIN}$ : 4.9435 V.

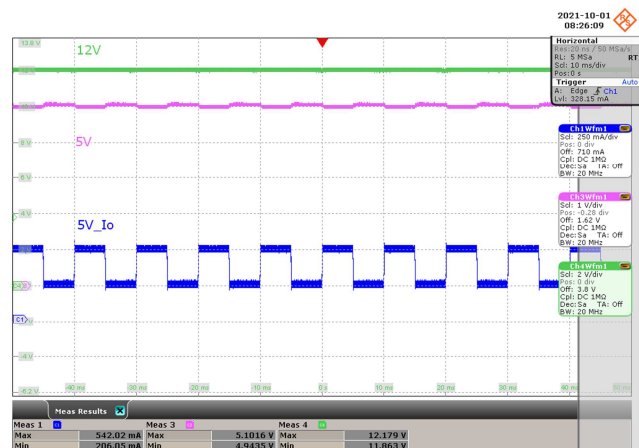


Figure 45 – 265 VAC 50 Hz.

CH1:  $I_{5V\_OUT}$ , 250 mA / div., 10 ms / div.  
 CH3:  $V_{5V\_OUT}$ , 1 V / div., 10 ms / div.  
 CH4:  $V_{12V\_OUT}$ , 2 V / div., 10 ms / div.  
 12 V<sub>OUT</sub>:  $V_{MAX}$ : 12.179 V,  $V_{MIN}$ : 11.863 V.  
 5 V<sub>OUT</sub>:  $V_{MAX}$ : 5.1016 V,  $V_{MIN}$ : 4.9435 V.



## 11.1.7 5 V Transient 10% - 100% Load Change (12 V, 10% Load)

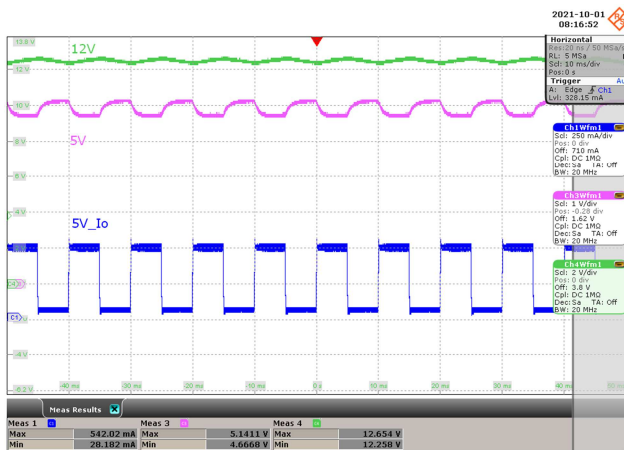


Figure 46 – 90 VAC 60 Hz.

CH1:  $I_{5V\_OUT}$ , 250 mA / div., 10 ms / div.  
 CH3:  $V_{5V\_OUT}$ , 1 V / div., 10 ms / div.  
 CH4:  $V_{12V\_OUT}$ , 2 V / div., 10 ms / div.  
 12 V<sub>OUT</sub>:  $V_{MAX}$ : 12.654 V,  $V_{MIN}$ : 12.258 V.  
 5 V<sub>OUT</sub>:  $V_{MAX}$ : 5.1411 V,  $V_{MIN}$ : 4.6668 V.

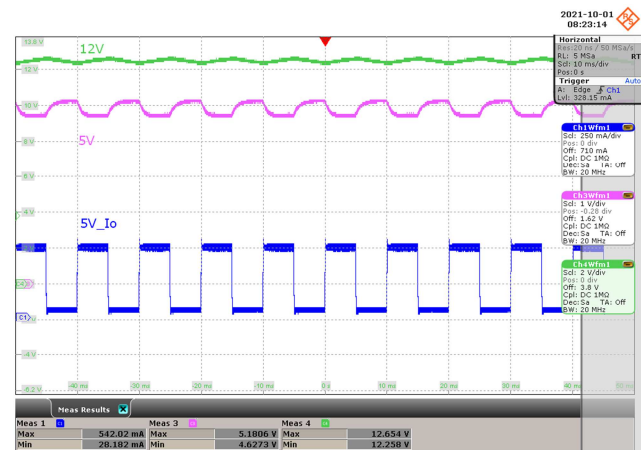


Figure 47 – 115 VAC 60 Hz.

CH1:  $I_{5V\_OUT}$ , 250 mA / div., 10 ms / div.  
 CH3:  $V_{5V\_OUT}$ , 1 V / div., 10 ms / div.  
 CH4:  $V_{12V\_OUT}$ , 2 V / div., 10 ms / div.  
 12 V<sub>OUT</sub>:  $V_{MAX}$ : 12.654 V,  $V_{MIN}$ : 12.258 V.  
 5 V<sub>OUT</sub>:  $V_{MAX}$ : 5.1806 V,  $V_{MIN}$ : 4.6273 V.

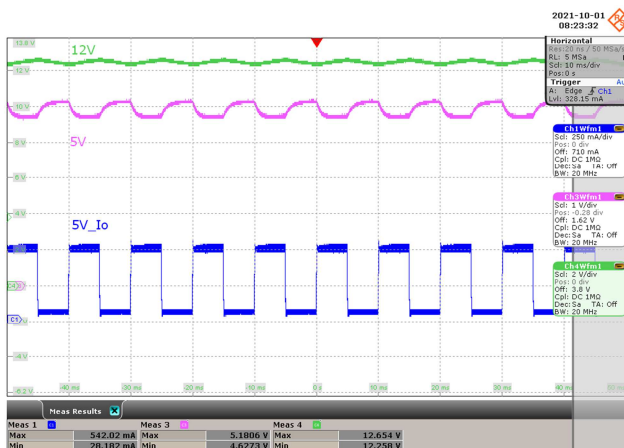


Figure 48 – 230 VAC 50 Hz.

CH1:  $I_{5V\_OUT}$ , 250 mA / div., 10 ms / div.  
 CH3:  $V_{5V\_OUT}$ , 1 V / div., 10 ms / div.  
 CH4:  $V_{12V\_OUT}$ , 2 V / div., 10 ms / div.  
 12 V<sub>OUT</sub>:  $V_{MAX}$ : 12.654 V,  $V_{MIN}$ : 12.258 V.  
 5 V<sub>OUT</sub>:  $V_{MAX}$ : 5.1806 V,  $V_{MIN}$ : 4.6273 V.

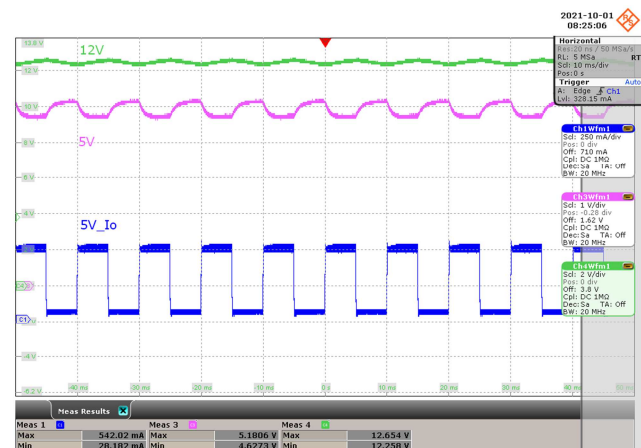


Figure 49 – 265 VAC 50 Hz.

CH1:  $I_{5V\_OUT}$ , 250 mA / div., 10 ms / div.  
 CH3:  $V_{5V\_OUT}$ , 1 V / div., 10 ms / div.  
 CH4:  $V_{12V\_OUT}$ , 2 V / div., 10 ms / div.  
 12 V<sub>OUT</sub>:  $V_{MAX}$ : 12.654 V,  $V_{MIN}$ : 12.258 V.  
 5 V<sub>OUT</sub>:  $V_{MAX}$ : 5.1806 V,  $V_{MIN}$ : 4.6273 V.

## 11.1.8 5 V Transient 50% - 100% Load Change (12 V, 10% Load)

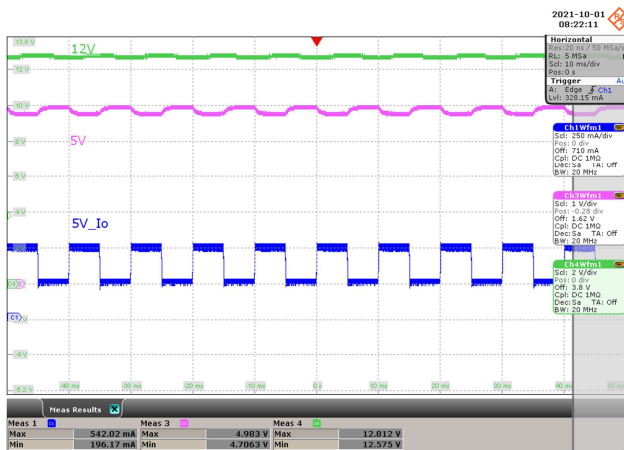


Figure 50 – 90 VAC 60 Hz.

CH1:  $I_{5V\_OUT}$ , 250 mA / div., 10 ms / div.  
 CH3:  $V_{5V\_OUT}$ , 1 V / div., 10 ms / div.  
 CH4:  $V_{12V\_OUT}$ , 2 V / div., 10 ms / div.  
 12 V<sub>OUT</sub>:  $V_{MAX}$ : 12.812 V,  $V_{MIN}$ : 12.575 V.  
 5 V<sub>OUT</sub>:  $V_{MAX}$ : 4.983 V,  $V_{MIN}$ : 4.7063 V.

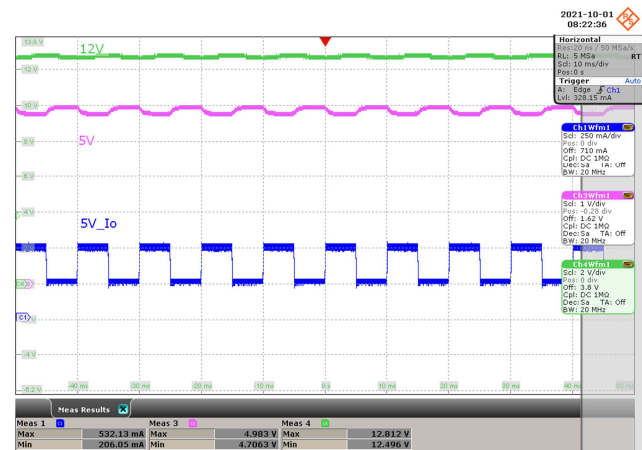


Figure 51 – 115 VAC 60 Hz.

CH1:  $I_{5V\_OUT}$ , 250 mA / div., 10 ms / div.  
 CH3:  $V_{5V\_OUT}$ , 1 V / div., 10 ms / div.  
 CH4:  $V_{12V\_OUT}$ , 2 V / div., 10 ms / div.  
 12 V<sub>OUT</sub>:  $V_{MAX}$ : 12.812 V,  $V_{MIN}$ : 12.496 V.  
 5 V<sub>OUT</sub>:  $V_{MAX}$ : 4.983 V,  $V_{MIN}$ : 4.7063 V.

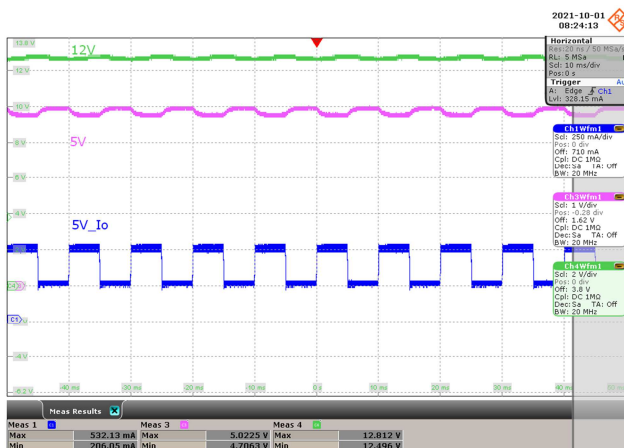


Figure 52 – 230 VAC 50 Hz.

CH1:  $I_{5V\_OUT}$ , 250 mA / div., 10 ms / div.  
 CH3:  $V_{5V\_OUT}$ , 1 V / div., 10 ms / div.  
 CH4:  $V_{12V\_OUT}$ , 2 V / div., 10 ms / div.  
 12 V<sub>OUT</sub>:  $V_{MAX}$ : 12.812 V,  $V_{MIN}$ : 12.496 V.  
 5 V<sub>OUT</sub>:  $V_{MAX}$ : 5.0225 V,  $V_{MIN}$ : 4.7063 V.

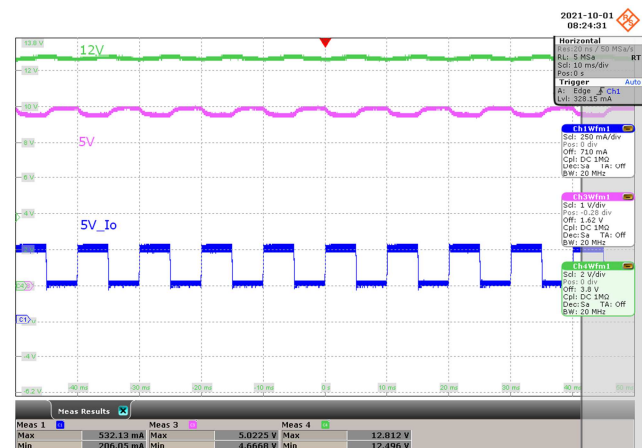
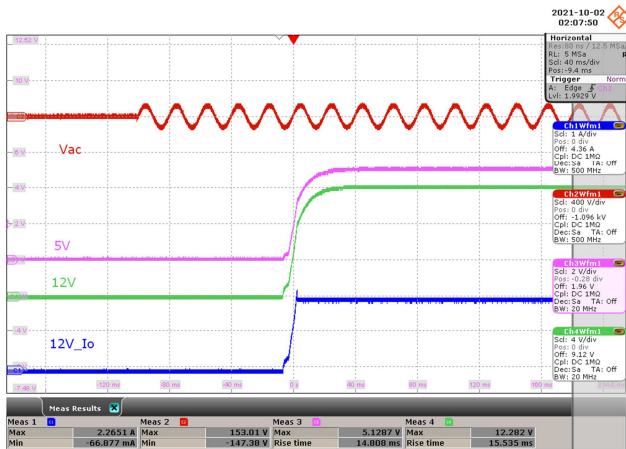


Figure 53 – 265 VAC 50 Hz.

CH1:  $I_{5V\_OUT}$ , 250 mA / div., 10 ms / div.  
 CH3:  $V_{5V\_OUT}$ , 1 V / div., 10 ms / div.  
 CH4:  $V_{12V\_OUT}$ , 2 V / div., 10 ms / div.  
 12 V<sub>OUT</sub>:  $V_{MAX}$ : 12.812 V,  $V_{MIN}$ : 12.496 V.  
 5 V<sub>OUT</sub>:  $V_{MAX}$ : 5.0225 V,  $V_{MIN}$ : 4.6668 V.

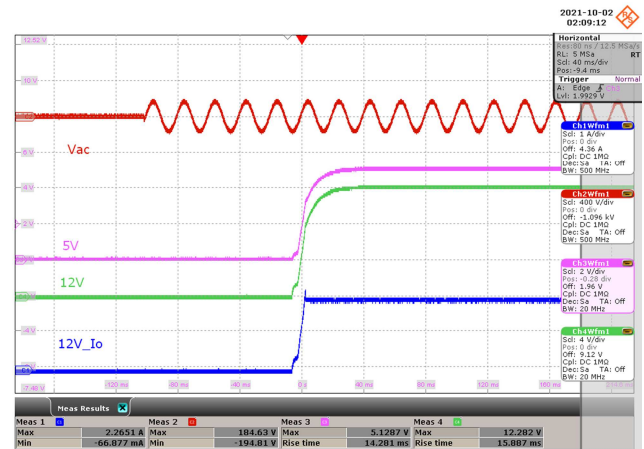
## 11.2 Output Start-up

### 11.2.1 Full Load CC Mode



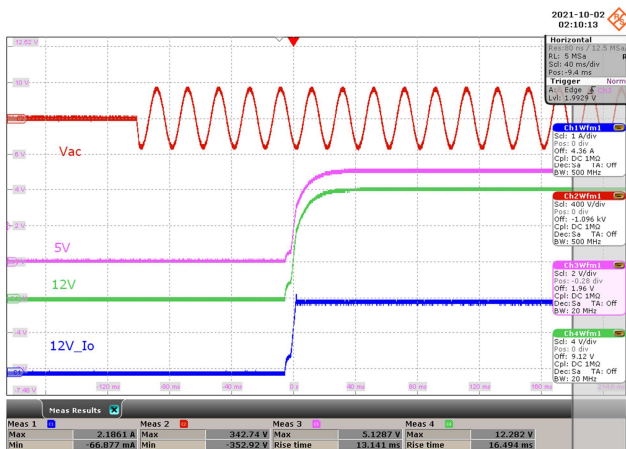
**Figure 54** – 90 VAC 60 Hz.

CH1:  $I_{12V\_OUT}$ , 1 A / div., 40 ms / div.  
 CH2:  $V_{IN}$ , 400 V / div., 40 ms / div.  
 CH3:  $V_{5V\_OUT}$ , 2 V / div., 40 ms / div.  
 CH4:  $V_{12V\_OUT}$ , 4 V / div., 40 ms / div.  
 Rise Time:  $V_{12V}$  = 15.53 ms.,  $V_{5V}$  = 14.80 ms.  
 $V_{MAX}$ :  $V_{12V}$  = 12.282 V,  $V_{5V}$  = 5.1287 V.



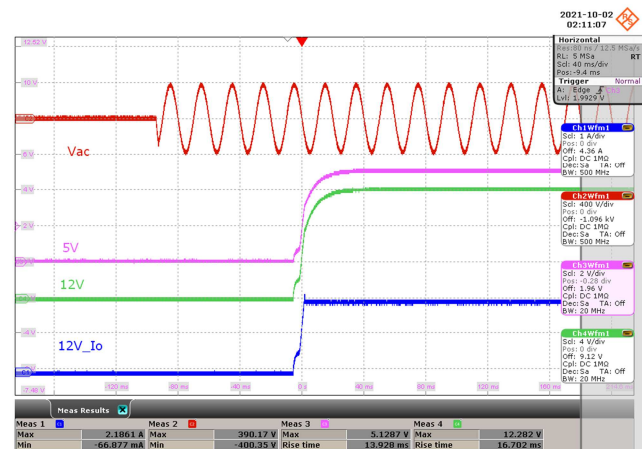
**Figure 55** – 115 VAC 60 Hz.

CH1:  $I_{12V\_OUT}$ , 1 A / div., 40 ms / div.  
 CH2:  $V_{IN}$ , 400 V / div., 40 ms / div.  
 CH3:  $V_{5V\_OUT}$ , 2 V / div., 40 ms / div.  
 CH4:  $V_{12V\_OUT}$ , 4 V / div., 40 ms / div.  
 Rise Time:  $V_{12V}$  = 15.88 ms.,  $V_{5V}$  = 14.28 ms.  
 $V_{MAX}$ :  $V_{12V}$  = 12.282 V,  $V_{5V}$  = 5.128 V.



**Figure 56** – 230 VAC 50 Hz.

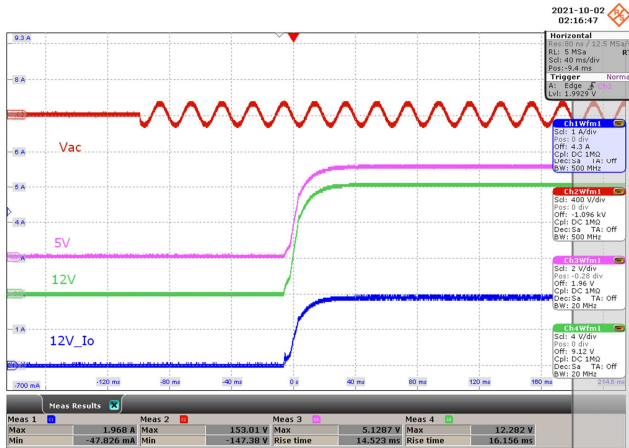
CH1:  $I_{12V\_OUT}$ , 1 A / div., 40 ms / div.  
 CH2:  $V_{IN}$ , 400 V / div., 40 ms / div.  
 CH3:  $V_{5V\_OUT}$ , 2 V / div., 40 ms / div.  
 CH4:  $V_{12V\_OUT}$ , 4 V / div., 40 ms / div.  
 Rise Time:  $V_{12V}$  = 16.49 ms.,  $V_{5V}$  = 13.14 ms.  
 $V_{MAX}$ :  $V_{12V}$  = 12.282 V,  $V_{5V}$  = 5.1287 V.



**Figure 57** – 265 VAC 50 Hz.

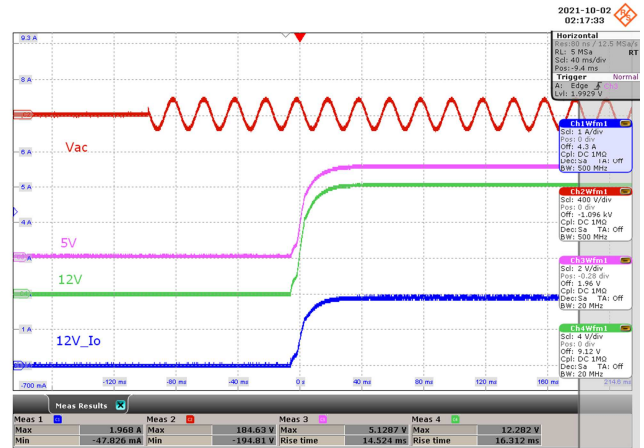
CH1:  $I_{12V\_OUT}$ , 1 A / div., 40 ms / div.  
 CH2:  $V_{IN}$ , 400 V / div., 40 ms / div.  
 CH3:  $V_{5V\_OUT}$ , 2 V / div., 40 ms / div.  
 CH4:  $V_{12V\_OUT}$ , 4 V / div., 40 ms / div.  
 Rise Time:  $V_{12V}$  = 16.70 ms.,  $V_{5V}$  = 13.92 ms.  
 $V_{MAX}$ :  $V_{12V}$  = 12.282 V,  $V_{5V}$  = 5.1287 V.

11.2.2 Full Load CR Mode



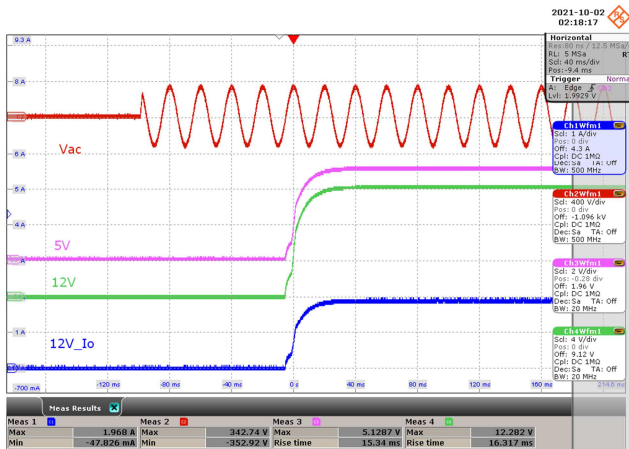
**Figure 58** – 90 VAC 60 Hz.

CH1:  $I_{12V\_OUT}$ , 1 A / div., 40 ms / div.  
 CH2:  $V_{IN}$ , 400 V / div., 40 ms / div.  
 CH3:  $V_{5V\_OUT}$ , 2 V / div., 40 ms / div.  
 CH4:  $V_{12V\_OUT}$ , 4 V / div., 40 ms / div.  
 Rise Time:  $V_{12V}$  = 16.15 ms.,  $V_{5V}$  = 14.52 ms.  
 $V_{MAX}$ :  $V_{12V}$  = 12.282 V,  $V_{5V}$  = 5.1287 V.



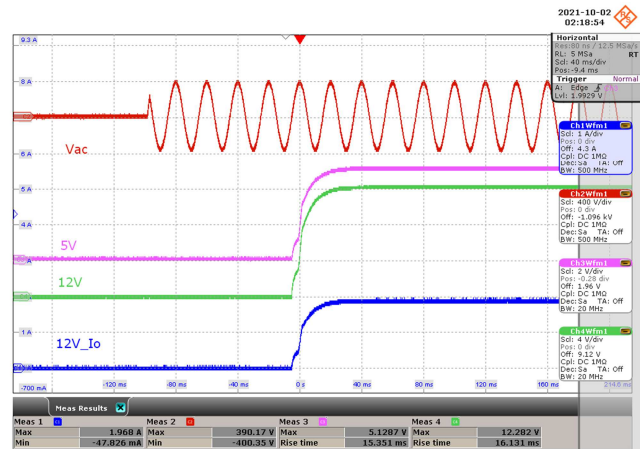
**Figure 59** – 115 VAC 60 Hz.

CH1:  $I_{12V\_OUT}$ , 1 A / div., 40 ms / div.  
 CH2:  $V_{IN}$ , 400 V / div., 40 ms / div.  
 CH3:  $V_{5V\_OUT}$ , 2 V / div., 40 ms / div.  
 CH4:  $V_{12V\_OUT}$ , 4 V / div., 40 ms / div.  
 Rise Time:  $V_{12V}$  = 16.31 ms.,  $V_{5V}$  = 14.52 ms.  
 $V_{MAX}$ :  $V_{12V}$  = 12.282 V,  $V_{5V}$  = 5.1287 V.



**Figure 60** – 230 VAC 50 Hz.

CH1:  $I_{12V\_OUT}$ , 1 A / div., 40 ms / div.  
 CH2:  $V_{IN}$ , 400 V / div., 40 ms / div.  
 CH3:  $V_{5V\_OUT}$ , 2 V / div., 40 ms / div.  
 CH4:  $V_{12V\_OUT}$ , 4 V / div., 40 ms / div.  
 Rise Time:  $V_{12V}$  = 16.31 ms.,  $V_{5V}$  = 15.34 ms.  
 $V_{MAX}$ :  $V_{12V}$  = 12.282 V,  $V_{5V}$  = 5.1287 V.



**Figure 61** – 265 VAC 50 Hz.

CH1:  $I_{12V\_OUT}$ , 1 A / div., 40 ms / div.  
 CH2:  $V_{IN}$ , 400 V / div., 40 ms / div.  
 CH3:  $V_{5V\_OUT}$ , 2 V / div., 40 ms / div.  
 CH4:  $V_{12V\_OUT}$ , 4 V / div., 40 ms / div.  
 Rise Time:  $V_{12V}$  = 16.13 ms.,  $V_{5V}$  = 15.35 ms.  
 $V_{MAX}$ :  $V_{12V}$  = 12.282 V,  $V_{5V}$  = 5.1287 V.



11.2.3 0% Load

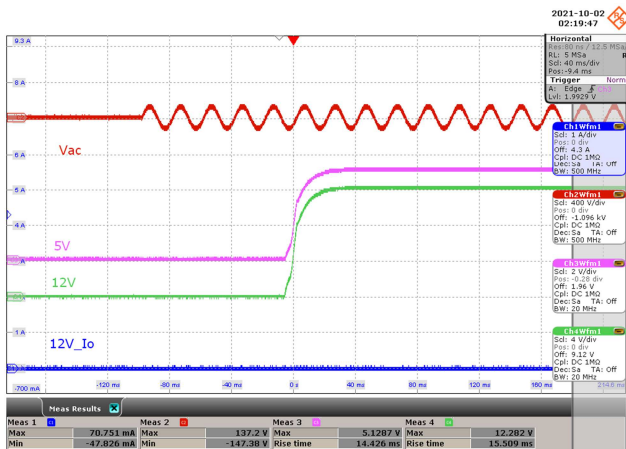


Figure 62 – 90 VAC 60 Hz.

CH1:  $I_{12V\_OUT}$ , 1 A / div., 40 ms / div.  
 CH2:  $V_{IN}$ , 400 V / div., 40 ms / div.  
 CH3:  $V_{5V\_OUT}$ , 2 V / div., 40 ms / div.  
 CH4:  $V_{12V\_OUT}$ , 4 V / div., 40 ms / div.  
 Rise Time:  $V_{12V}$  = 15.50 ms,  $V_{5V}$  = 14.42 ms.  
 $V_{MAX}$ :  $V_{12V}$  = 12.282 V,  $V_{5V}$  = 5.1287 V.

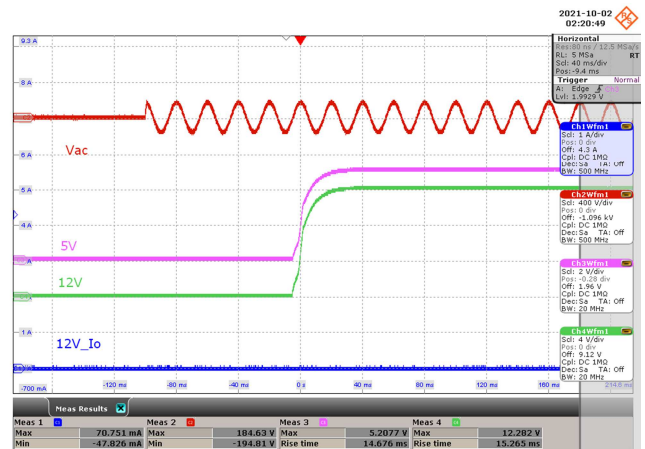


Figure 63 – 115 VAC 60 Hz.

CH1:  $I_{12V\_OUT}$ , 1 A / div., 40 ms / div.  
 CH2:  $V_{IN}$ , 400 V / div., 40 ms / div.  
 CH3:  $V_{5V\_OUT}$ , 2 V / div., 40 ms / div.  
 CH4:  $V_{12V\_OUT}$ , 4 V / div., 40 ms / div.  
 Rise Time:  $V_{12V}$  = 15.26 ms,  $V_{5V}$  = 14.67 ms.  
 $V_{MAX}$ :  $V_{12V}$  = 12.282 V,  $V_{5V}$  = 5.2077 V.

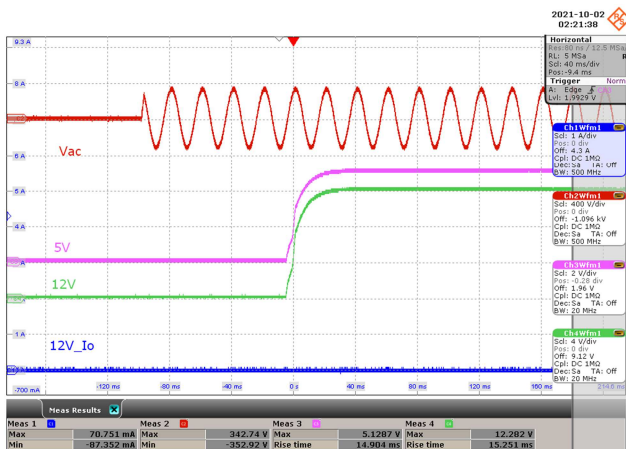


Figure 64 – 230 VAC 50 Hz.

CH1:  $I_{12V\_OUT}$ , 1 A / div., 40 ms / div.  
 CH2:  $V_{IN}$ , 400 V / div., 40 ms / div.  
 CH3:  $V_{5V\_OUT}$ , 2 V / div., 40 ms / div.  
 CH4:  $V_{12V\_OUT}$ , 4 V / div., 40 ms / div.  
 Rise Time:  $V_{12V}$  = 15.25 ms,  $V_{5V}$  = 14.90 ms.  
 $V_{MAX}$ :  $V_{12V}$  = 12.282 V,  $V_{5V}$  = 5.1287 V.

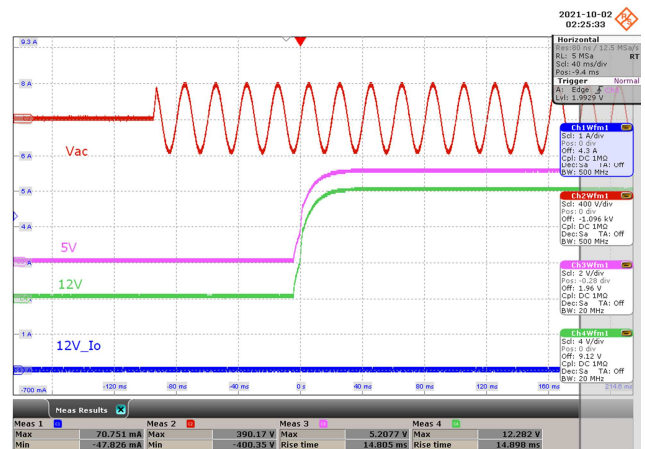


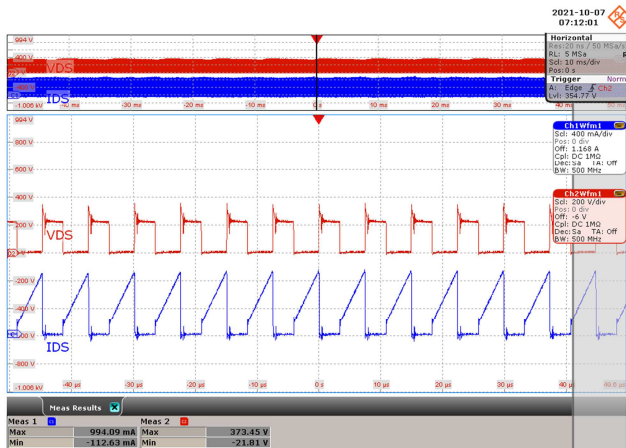
Figure 65 – 265 VAC 50 Hz.

CH1:  $I_{12V\_OUT}$ , 1 A / div., 40 ms / div.  
 CH2:  $V_{IN}$ , 400 V / div., 40 ms / div.  
 CH3:  $V_{5V\_OUT}$ , 2 V / div., 40 ms / div.  
 CH4:  $V_{12V\_OUT}$ , 4 V / div., 40 ms / div.  
 Rise Time:  $V_{12V}$  = 14.89 ms,  $V_{5V}$  = 14.80 ms.  
 $V_{MAX}$ :  $V_{12V}$  = 12.282 V,  $V_{5V}$  = 5.2077 V.

## 11.3 Switching Waveforms

### 11.3.1 Primary MOSFET Drain-Source Voltage and Current at Normal Operation

#### 11.3.1.1 100% Load



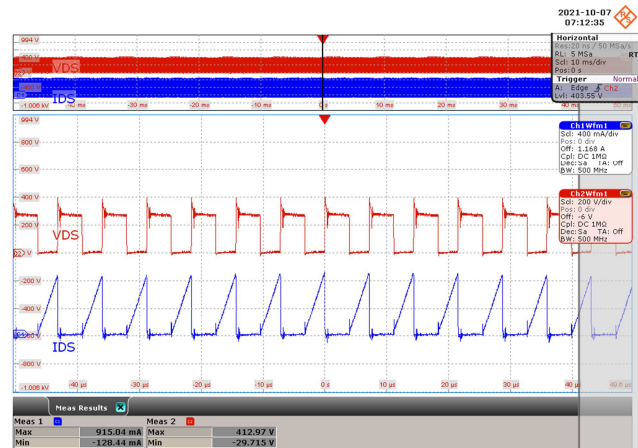
**Figure 66** – 90 VAC 60 Hz.

CH1:  $I_{DS}$ , 400 mA / div., 10 ms / div.

CH2:  $V_{DS}$ , 200 V / div., 10 ms / div.

Zoom: 10  $\mu$ s / div.

$V_{DS(MAX)} = 373.45$  V,  $I_{DS(MAX)} = 0.994$  A.



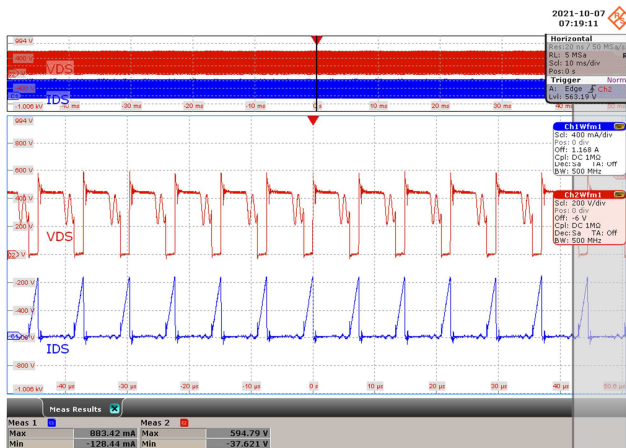
**Figure 67** – 115 VAC 60 Hz.

CH1:  $I_{DS}$ , 400 mA / div., 10 ms / div.

CH2:  $V_{DS}$ , 200 V / div., 10 ms / div.

Zoom: 10  $\mu$ s / div.

$V_{DS(MAX)} = 412.97$  V,  $I_{DS(MAX)} = 0.915$  A.



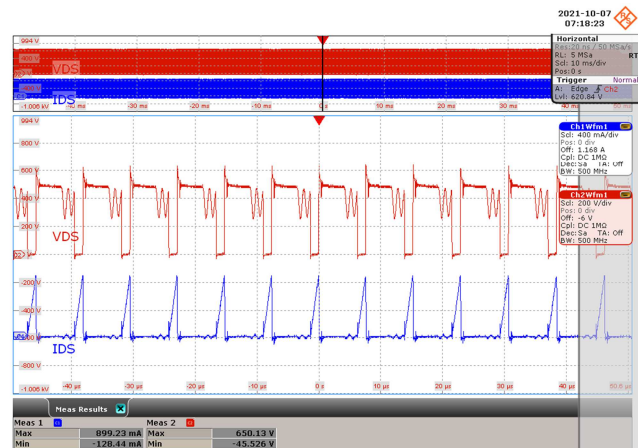
**Figure 68** – 230 VAC 50 Hz.

CH1:  $I_{DS}$ , 400 mA / div., 10 ms / div.

CH2:  $V_{DS}$ , 200 V / div., 10 ms / div.

Zoom: 10  $\mu$ s / div.

$V_{DS(MAX)} = 594.79$  V,  $I_{DS(MAX)} = 0.883$  A.



**Figure 69** – 265 VAC 50 Hz.

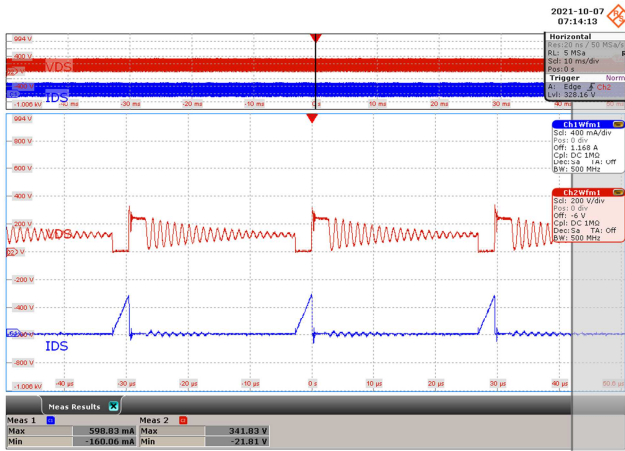
CH1:  $I_{DS}$ , 400 mA / div., 10 ms / div.

CH2:  $V_{DS}$ , 200 V / div., 10 ms / div.

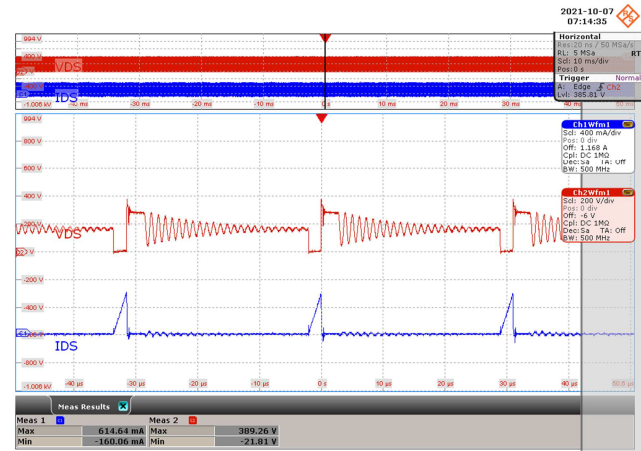
Zoom: 10  $\mu$ s / div.

$V_{DS(MAX)} = 650.13$  V,  $I_{DS(MAX)} = 0.899$  A.

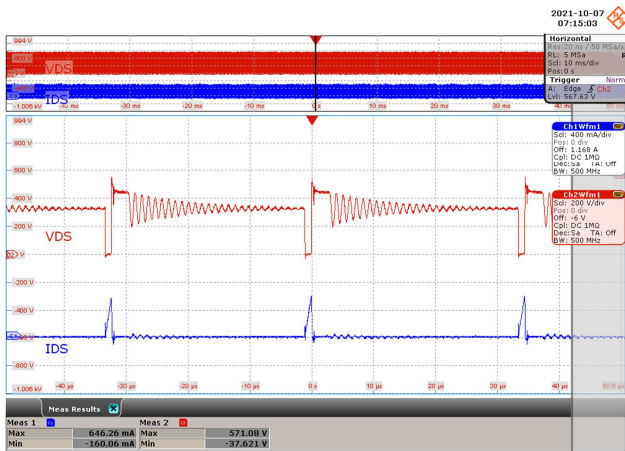
11.3.1.2 10% Load



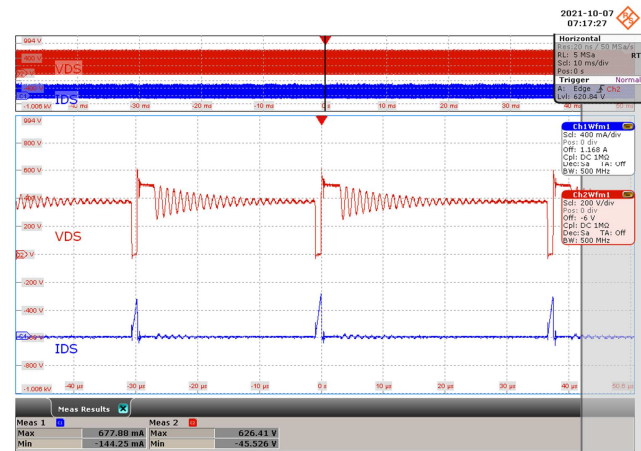
**Figure 70 – 90 VAC 60 Hz.**  
 CH1:  $I_{DS}$ , 400 mA / div., 10 ms / div.  
 CH2:  $V_{DS}$ , 200 V / div., 10 ms / div.  
 Zoom: 10  $\mu$ s / div.  
 $V_{DS(MAX)} = 341.83$  V,  $I_{DS(MAX)} = 0.598$  A.



**Figure 71 – 115 VAC 60 Hz.**  
 CH1:  $I_{DS}$ , 400 mA / div., 10 ms / div.  
 CH2:  $V_{DS}$ , 200 V / div., 10 ms / div.  
 Zoom: 10  $\mu$ s / div.  
 $V_{DS(MAX)} = 389.26$  V,  $I_{DS(MAX)} = 0.614$  A.



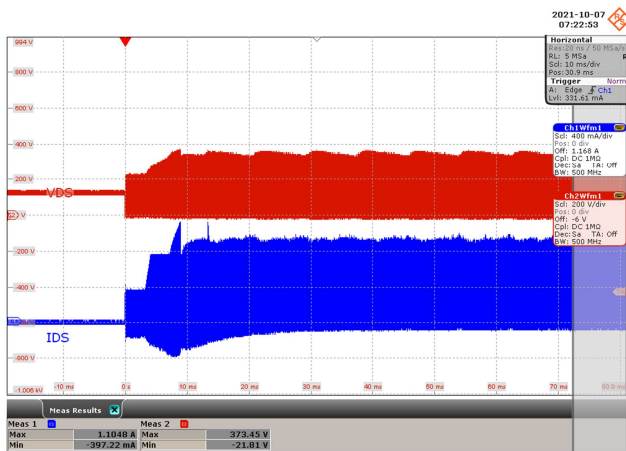
**Figure 72 – 230 VAC 50 Hz.**  
 CH1:  $I_{DS}$ , 400 mA / div., 10 ms / div.  
 CH2:  $V_{DS}$ , 200 V / div., 10 ms / div.  
 Zoom: 10  $\mu$ s / div.  
 $V_{DS(MAX)} = 571.08$  V,  $I_{DS(MAX)} = 0.646$  A.



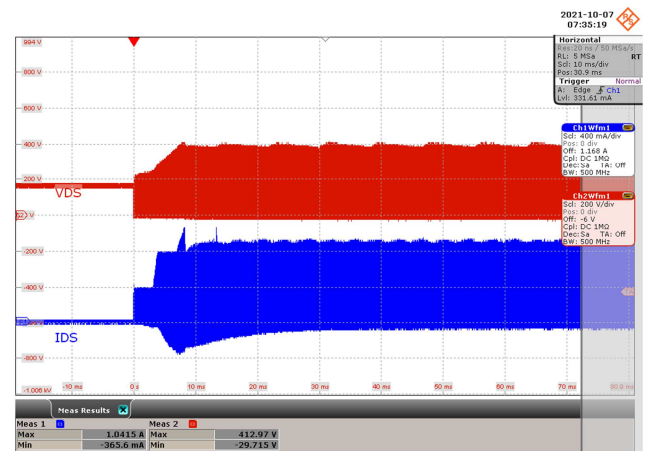
**Figure 73 – 265 VAC 50 Hz.**  
 CH1:  $I_{DS}$ , 400 mA / div., 10 ms / div.  
 CH2:  $V_{DS}$ , 200 V / div., 10 ms / div.  
 Zoom: 10  $\mu$ s / div.  
 $V_{DS(MAX)} = 626.41$  V,  $I_{DS(MAX)} = 0.677$  A.

### 11.3.2 Primary MOSFET Drain-Source Voltage and Current at Start-up Operation

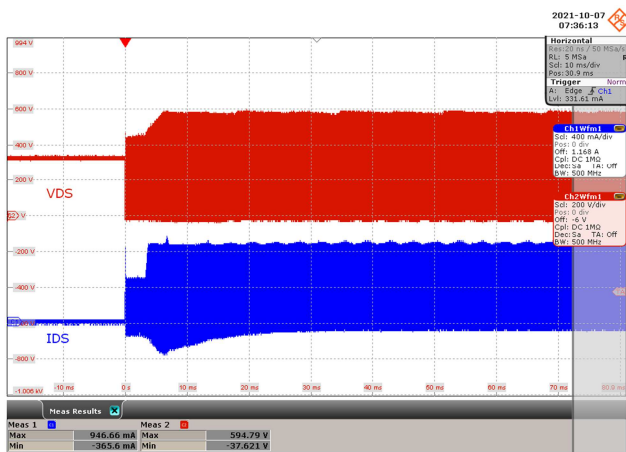
#### 11.3.2.1 100% Load



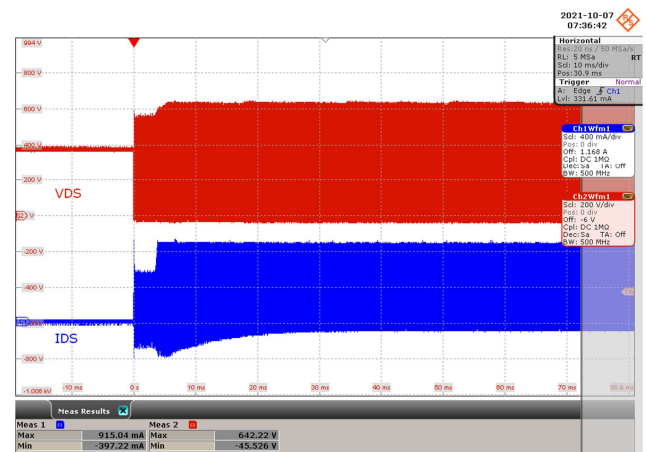
**Figure 74** – 90 VAC 60 Hz.  
 CH1:  $I_{DS}$ , 400 mA / div., 10 ms / div.  
 CH2:  $V_{DS}$ , 200 V / div., 10 ms / div.  
 $V_{DS(MAX)} = 373.45$  V,  $I_{DS(MAX)} = 1.1048$  A.



**Figure 75** – 115 VAC 60 Hz.  
 CH1:  $I_{DS}$ , 400 mA / div., 10 ms / div.  
 CH2:  $V_{DS}$ , 200 V / div., 10 ms / div.  
 $V_{DS(MAX)} = 412.97$  V,  $I_{DS(MAX)} = 1.0415$  A.



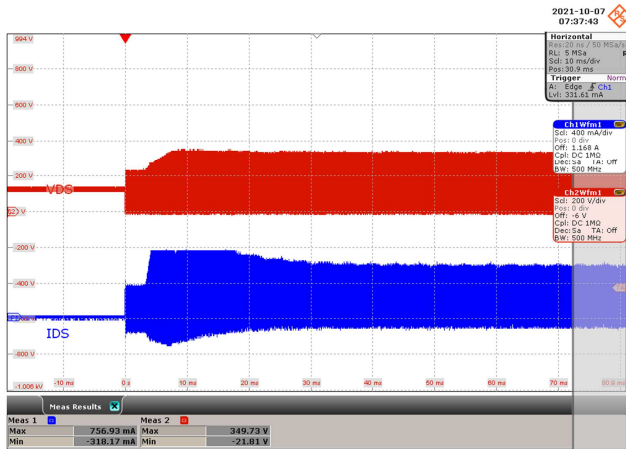
**Figure 76** – 230 VAC 50 Hz.  
 CH1:  $I_{DS}$ , 400 mA / div., 10 ms / div.  
 CH2:  $V_{DS}$ , 200 V / div., 10 ms / div.  
 $V_{DS(MAX)} = 594.79$  V,  $I_{DS(MAX)} = 0.946$  A.



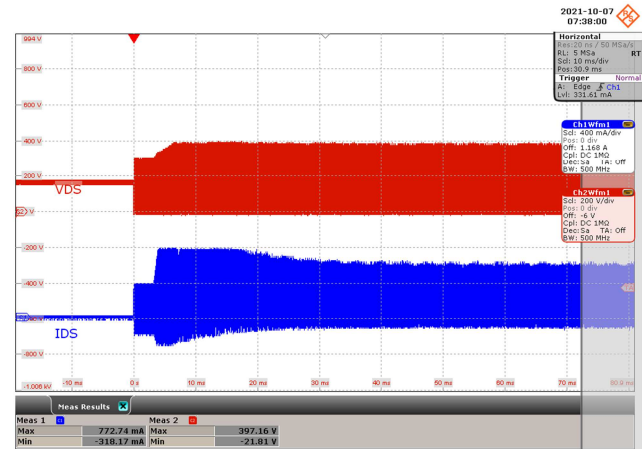
**Figure 77** – 265 VAC 50 Hz.  
 CH1:  $I_{DS}$ , 400 mA / div., 10 ms / div.  
 CH2:  $V_{DS}$ , 200 V / div., 10 ms / div.  
 $V_{DS(MAX)} = 642.22$  V,  $I_{DS(MAX)} = 0.915$  A.



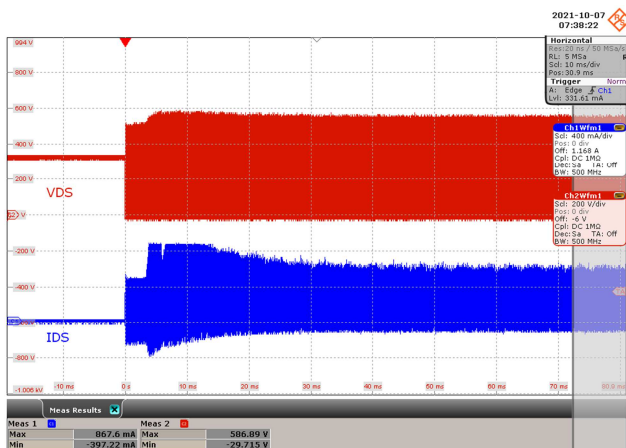
11.3.2.2 10% Load



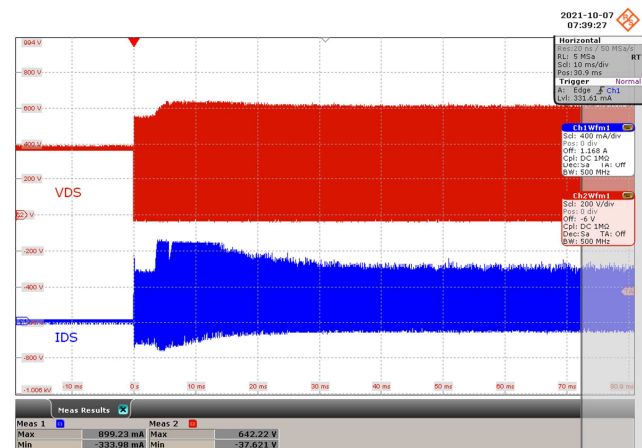
**Figure 78** – 90 VAC 60 Hz.  
 CH1:  $I_{DS}$ , 400 mA / div., 10 ms / div.  
 CH2:  $V_{DS}$ , 200 V / div., 10 ms / div.  
 $V_{DS(MAX)} = 349.73$  V,  $I_{DS(MAX)} = 0.756$  A.



**Figure 79** – 115 VAC 60 Hz.  
 CH1:  $I_{DS}$ , 400 mA / div., 10 ms / div.  
 CH2:  $V_{DS}$ , 200 V / div., 10 ms / div.  
 $V_{DS(MAX)} = 397.16$  V,  $I_{DS(MAX)} = 0.772$  A.



**Figure 80** – 230 VAC 50 Hz.  
 CH1:  $I_{DS}$ , 400 mA / div., 10 ms / div.  
 CH2:  $V_{DS}$ , 200 V / div., 10 ms / div.  
 $V_{DS(MAX)} = 586.89$  V,  $I_{DS(MAX)} = 0.867$  A.



**Figure 81** – 265 VAC 50 Hz.  
 CH1:  $I_{DS}$ , 400 mA / div., 10 ms / div.  
 CH2:  $V_{DS}$ , 200 V / div., 10 ms / div.  
 $V_{DS(MAX)} = 642.22$  V,  $I_{DS(MAX)} = 0.899$  A.

## 11.3.3 12 V Freewheeling Diode Voltage and Current at Normal Operation

## 11.3.3.1 100% Load

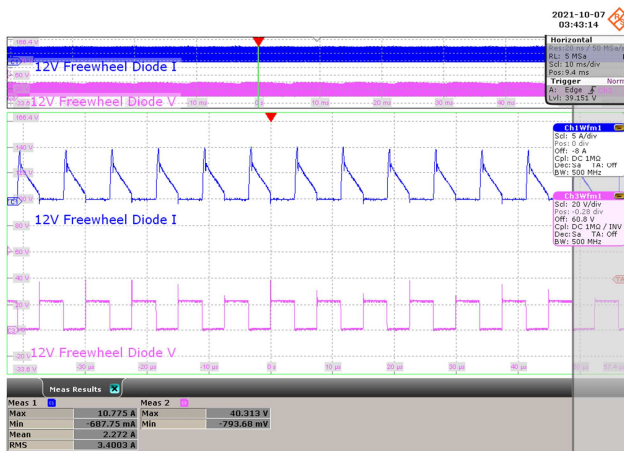


Figure 82 – 90 VAC 60 Hz.

CH1:  $I_{12V\_Diode}$ , 5 A / div., 10 ms / div.  
 CH3:  $V_{12V\_Diode}$ , 20 V / div., 10 ms / div.  
 Zoom: 10  $\mu$ s / div.  
 PIV = 40.313 V,  $I_{D(MEAN)}$  = 2.272 A.



Figure 83 – 115 VAC 60 Hz.

CH1:  $I_{12V\_Diode}$ , 5 A / div., 10 ms / div.  
 CH3:  $V_{12V\_Diode}$ , 20 V / div., 10 ms / div.  
 Zoom: 10  $\mu$ s / div.  
 PIV = 41.104 V,  $I_{D(MEAN)}$  = 2.2819 A.



Figure 84 – 230 VAC 50 Hz.

CH1:  $I_{12V\_Diode}$ , 5 A / div., 10 ms / div.  
 CH3:  $V_{12V\_Diode}$ , 20 V / div., 10 ms / div.  
 Zoom: 10  $\mu$ s / div.  
 PIV = 46.637 V,  $I_{D(MEAN)}$  = 2.278 A.



Figure 85 – 265 VAC 50 Hz.

CH1:  $I_{12V\_Diode}$ , 5 A / div., 10 ms / div.  
 CH3:  $V_{12V\_Diode}$ , 20 V / div., 10 ms / div.  
 Zoom: 10  $\mu$ s / div.  
 PIV = 51.38 V,  $I_{D(MEAN)}$  = 2.2651 A.

11.3.3.2 10% Load



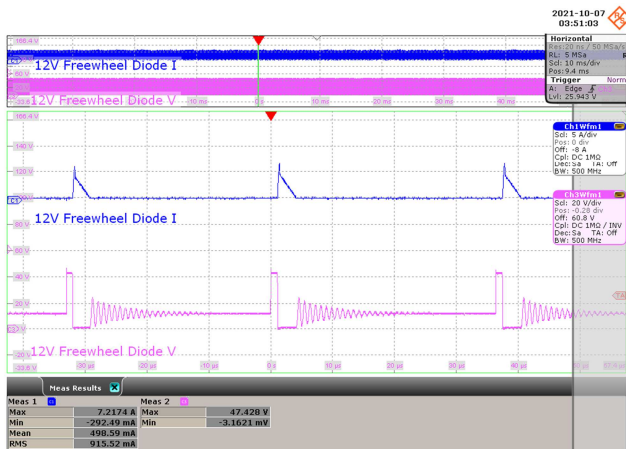
**Figure 86** – 90 VAC 60 Hz.

CH1:  $I_{12V\_Diode}$ , 5 A / div., 10 ms / div.  
 CH3:  $V_{12V\_Diode}$ , 20 V / div., 10 ms / div.  
 Zoom: 10  $\mu$ s / div.  
 PIV = 26.874 V,  $I_{D(MEAN)}$  = 0.489 A.



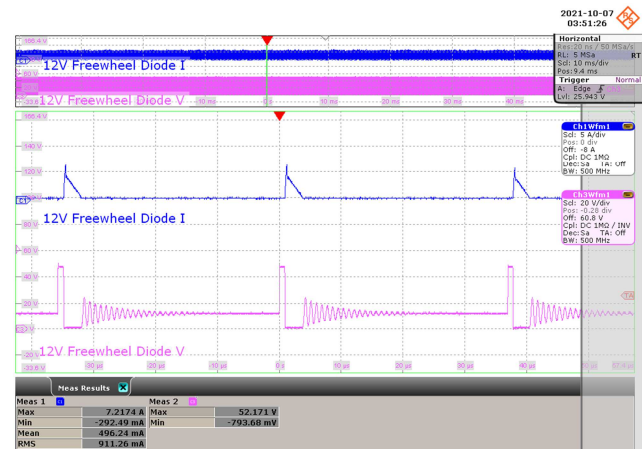
**Figure 87** – 115 VAC 60 Hz.

CH1:  $I_{12V\_Diode}$ , 5 A / div., 10 ms / div.  
 CH3:  $V_{12V\_Diode}$ , 20 V / div., 10 ms / div.  
 Zoom: 10  $\mu$ s / div.  
 PIV = 30.827 V,  $I_{D(MEAN)}$  = 0.494 A.



**Figure 88** – 230 VAC 50 Hz.

CH1:  $I_{12V\_Diode}$ , 5 A / div., 10 ms / div.  
 CH3:  $V_{12V\_Diode}$ , 20 V / div., 10 ms / div.  
 Zoom: 10  $\mu$ s / div.  
 PIV = 47.428 V,  $I_{D(MEAN)}$  = 0.498 A.



**Figure 89** – 265 VAC 50 Hz.

CH1:  $I_{12V\_Diode}$ , 5 A / div., 10 ms / div.  
 CH3:  $V_{12V\_Diode}$ , 20 V / div., 10 ms / div.  
 Zoom: 10  $\mu$ s / div.  
 PIV = 52.171 V,  $I_{D(MEAN)}$  = 0.496 A.

## 11.3.4 5 V Freewheeling Diode Voltage and Current at Normal Operation

## 11.3.4.1 100% Load



Figure 90 – 90 VAC 60 Hz.

CH1:  $I_{5V\_Diode}$ , 1 A / div., 10 ms / div.CH3:  $V_{5V\_Diode}$ , 10 V / div., 10 ms / div.Zoom: 10  $\mu$ s / div.PIV = 15.818 V,  $I_{D(MEAN)}$  = 0.451 A.

Figure 91 – 115 VAC 60 Hz.

CH1:  $I_{5V\_Diode}$ , 1 A / div., 10 ms / div.CH3:  $V_{5V\_Diode}$ , 10 V / div., 10 ms / div.Zoom: 10  $\mu$ s / div.PIV = 17.399 V,  $I_{D(MEAN)}$  = 0.453 A.

Figure 92 – 230 VAC 50 Hz.

CH1:  $I_{5V\_Diode}$ , 1 A / div., 10 ms / div.CH3:  $V_{5V\_Diode}$ , 10 V / div., 10 ms / div.Zoom: 10  $\mu$ s / div.PIV = 21.747 V,  $I_{D(MEAN)}$  = 0.452 A.

Figure 93 – 265 VAC 50 Hz.

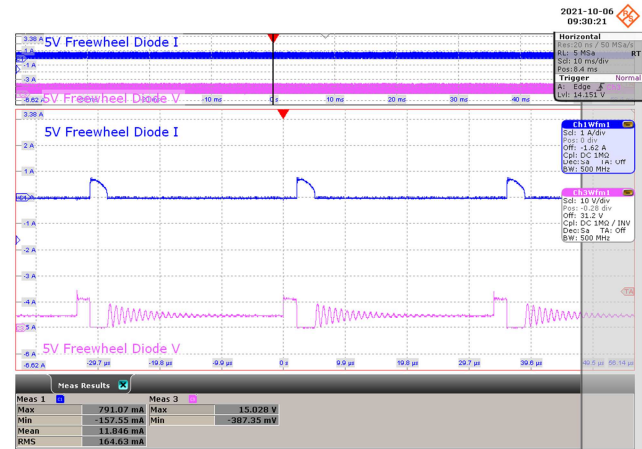
CH1:  $I_{5V\_Diode}$ , 1 A / div., 10 ms / div.CH3:  $V_{5V\_Diode}$ , 10 V / div., 10 ms / div.Zoom: 10  $\mu$ s / div.PIV = 24.119 V,  $I_{D(MEAN)}$  = 0.454 A.



11.3.4.2 10% Load



**Figure 94 – 90 VAC 60 Hz.**  
 CH1:  $I_{5V\_Diode}$ , 1 A / div., 10 ms / div.  
 CH3:  $V_{5V\_Diode}$ , 10 V / div., 10 ms / div.  
 Zoom: 10  $\mu$ s / div.  
 PIV = 12.261 V,  $I_{D(MEAN)}$  = 0.011 A.



**Figure 95 – 115 VAC 60 Hz.**  
 CH1:  $I_{5V\_Diode}$ , 1 A / div., 10 ms / div.  
 CH3:  $V_{5V\_Diode}$ , 10 V / div., 10 ms / div.  
 Zoom: 10  $\mu$ s / div.  
 PIV = 15.028 V,  $I_{D(MEAN)}$  = 0.011 A.

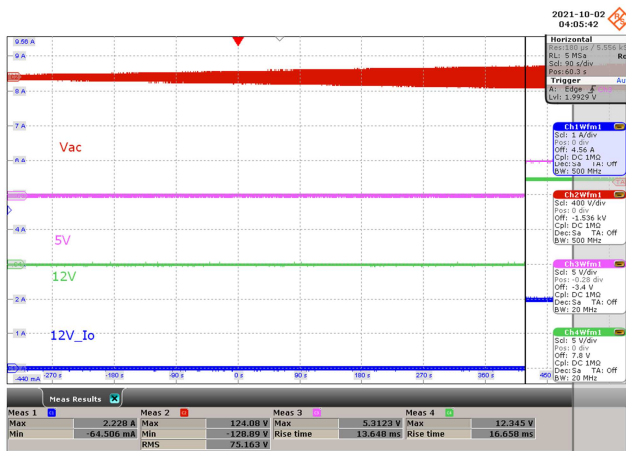


**Figure 96 – 230 VAC 50 Hz.**  
 CH1:  $I_{5V\_Diode}$ , 1 A / div., 10 ms / div.  
 CH3:  $V_{5V\_Diode}$ , 10 V / div., 10 ms / div.  
 Zoom: 10  $\mu$ s / div.  
 PIV = 22.538 V,  $I_{D(MEAN)}$  = 0.012 A.

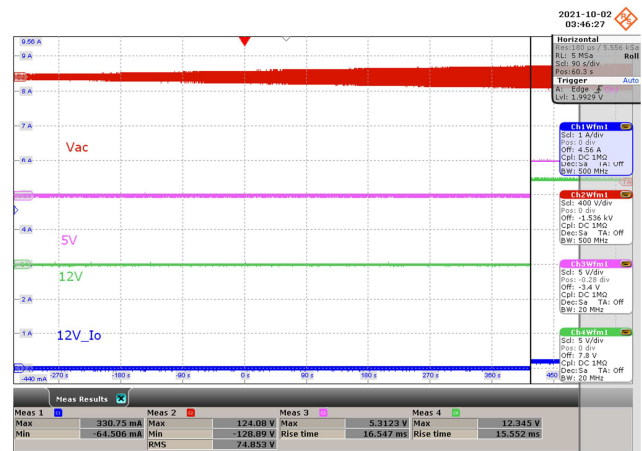


**Figure 97 – 265 VAC 50 Hz.**  
 CH1:  $I_{5V\_Diode}$ , 1 A / div., 10 ms / div.  
 CH3:  $V_{5V\_Diode}$ , 10 V / div., 10 ms / div.  
 Zoom: 10  $\mu$ s / div.  
 PIV = 24.514 V,  $I_{D(MEAN)}$  = 0.011 A.

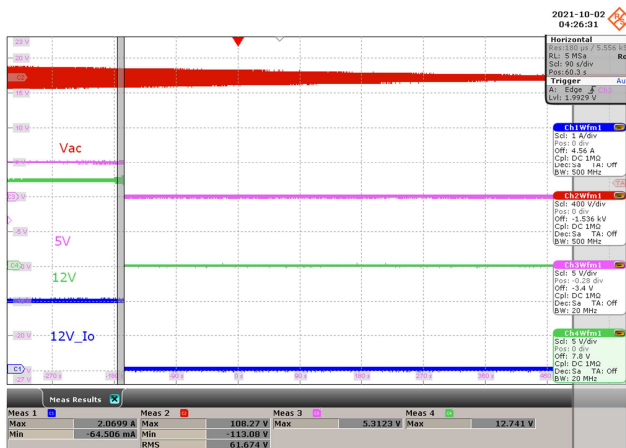
11.4 **Brown-In and Brown-Out**



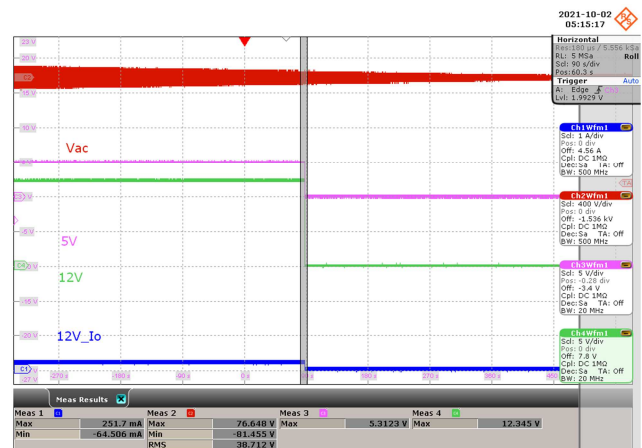
**Figure 98 – Brown-In Full Load.**  
 CH1:  $I_{12V\_OUT}$ , 1 A / div., 90 s / div.  
 CH2:  $V_{IN}$ , 400 V / div., 90 s / div.  
 CH3:  $V_{5V\_OUT}$ , 5 V / div., 90 s / div.  
 CH4:  $V_{12V\_OUT}$ , 5 V / div., 90 s / div.  
 $V_{IN(UV)} = 75.163 V_{RMS}$ .



**Figure 99 – Brown-In Minimum Load.**  
 CH1:  $I_{12V\_OUT}$ , 1 A / div., 90 s / div.  
 CH2:  $V_{IN}$ , 400 V / div., 90 s / div.  
 CH3:  $V_{5V\_OUT}$ , 5 V / div., 90 s / div.  
 CH4:  $V_{12V\_OUT}$ , 5 V / div., 90 s / div.  
 $V_{IN(UV)} = 74.853 V_{RMS}$ .



**Figure 100 – Brown-Out Full Load.**  
 CH1:  $I_{12V\_OUT}$ , 1 A / div., 90 s / div.  
 CH2:  $V_{IN}$ , 400 V / div., 90 s / div.  
 CH3:  $V_{5V\_OUT}$ , 5 V / div., 90 s / div.  
 CH4:  $V_{12V\_OUT}$ , 5 V / div., 90 s / div.  
 $V_{IN(UV)} = 61.674 V_{RMS}$ .



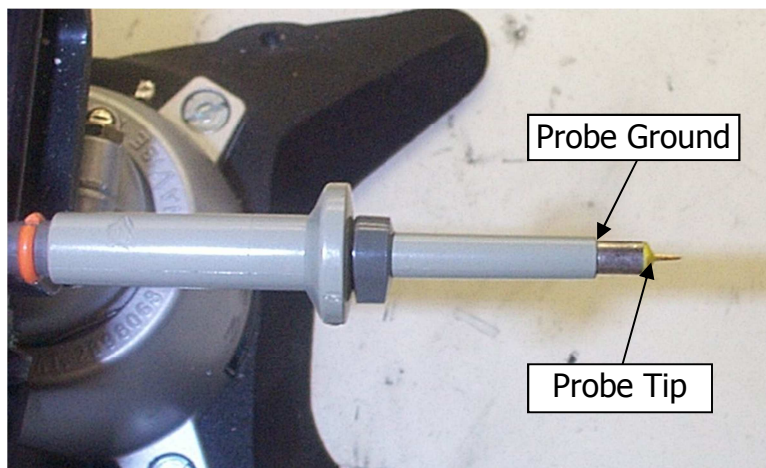
**Figure 101 – Brown-Out Minimum Load.**  
 CH1:  $I_{12V\_OUT}$ , 1 A / div., 90 s / div.  
 CH2:  $V_{IN}$ , 400 V / div., 90 s / div.  
 CH3:  $V_{5V\_OUT}$ , 5 V / div., 90 s / div.  
 CH4:  $V_{12V\_OUT}$ , 5 V / div., 90 s / div.  
 $V_{IN(UV)} = 38.712 V_{RMS}$ .

## 11.5 **Output Voltage Ripple**

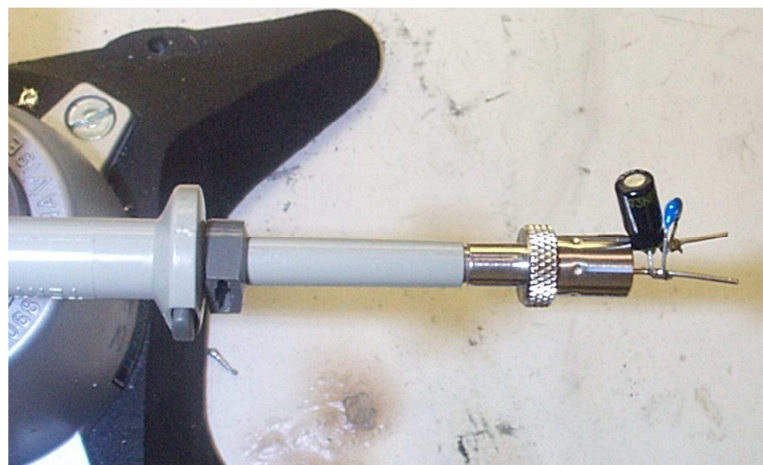
### 11.5.1 Ripple Measurement Technique

For DC output ripple measurements, a modified oscilloscope test probe must be utilized to reduce spurious signals due to pick-up. Details of the probe modification are provided in the Figures below.

The 4987BA probe adapter is affixed with two capacitors tied in parallel across the probe tip. The capacitors include one (1) 0.1  $\mu\text{F}$  / 50 V ceramic type and one (1) 47  $\mu\text{F}$  / 50 V aluminum electrolytic. The aluminum electrolytic type capacitor is polarized, so proper polarity across DC outputs must be maintained (see below).



**Figure 102** – Oscilloscope Probe Prepared for Ripple Measurement. (End Cap and Ground Lead Removed.)

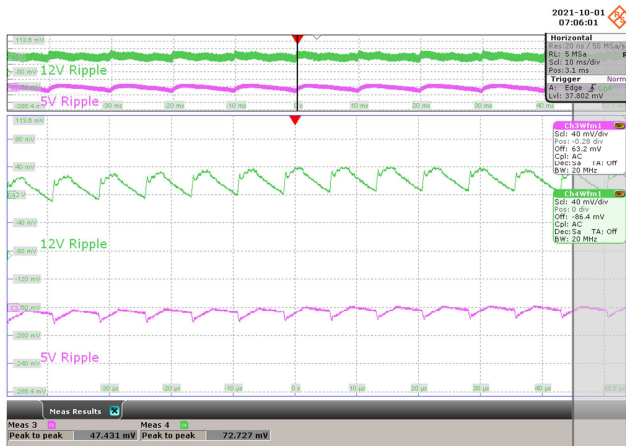


**Figure 103** – Oscilloscope Probe with Probe Master ([www.probemaster.com](http://www.probemaster.com)) 4987A BNC Adapter. (Modified with wires for ripple measurement, and two parallel decoupling capacitors added.)

## 11.5.2 Measurement Results

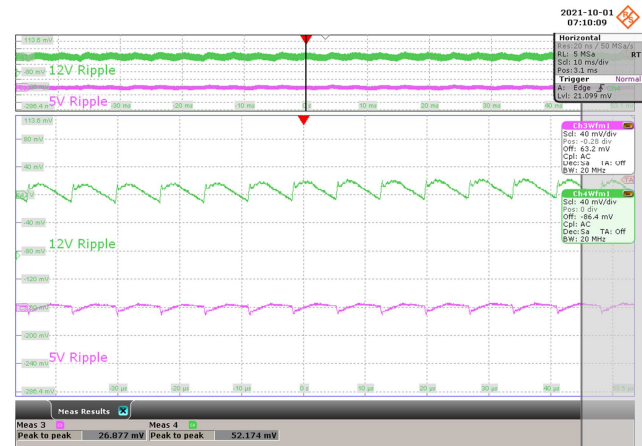
Note: All ripple measurements were taken at PCB end.

## 11.5.2.1 100% Load Condition



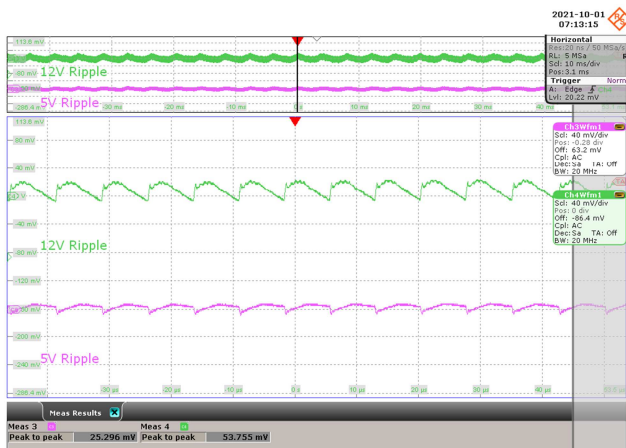
**Figure 104** – 90 VAC 60 Hz.

CH3:  $V_{5V\_Ripple}$ , 40 mV / div., 10 ms / div.  
 CH4:  $V_{12V\_Ripple}$ , 40 mV / div., 10 ms / div.  
 Zoom: 10  $\mu$ s / div.  
 5 V Output Ripple = 47.431 mV.  
 12 V Output Ripple = 72.727 mV.



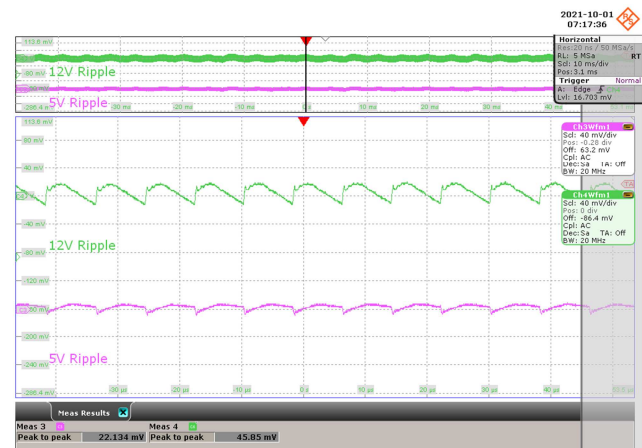
**Figure 105** – 115 VAC 60 Hz.

CH3:  $V_{5V\_Ripple}$ , 40 mV / div., 10 ms / div.  
 CH4:  $V_{12V\_Ripple}$ , 40 mV / div., 10 ms / div.  
 Zoom: 10  $\mu$ s / div.  
 5 V Output Ripple = 26.877 mV.  
 12 V Output Ripple = 52.174 mV.



**Figure 106** – 230 VAC 50 Hz.

CH3:  $V_{5V\_Ripple}$ , 40 mV / div., 10 ms / div.  
 CH4:  $V_{12V\_Ripple}$ , 40 mV / div., 10 ms / div.  
 Zoom: 10  $\mu$ s / div.  
 5 V Output Ripple = 25.296 mV.  
 12 V Output Ripple = 53.755 mV.



**Figure 107** – 265 VAC 50 Hz.

CH3:  $V_{5V\_Ripple}$ , 40 mV / div., 10 ms / div.  
 CH4:  $V_{12V\_Ripple}$ , 40 mV / div., 10 ms / div.  
 Zoom: 10  $\mu$ s / div.  
 5 V Output Ripple = 22.134 mV.  
 12 V Output Ripple = 45.85 mV.



## 11.5.2.2 75% Load Condition

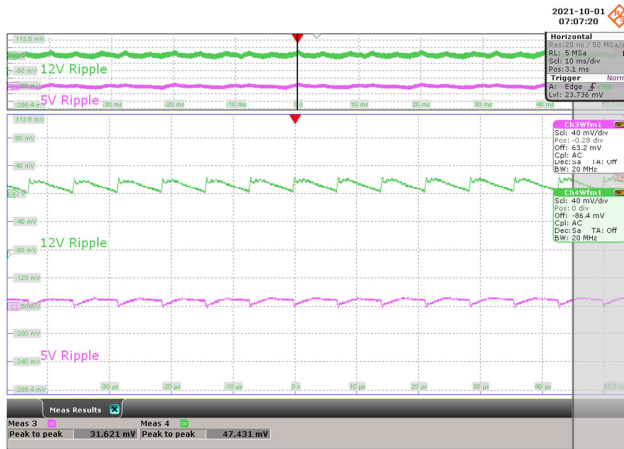


Figure 108 – 90 VAC 60 Hz.

CH3:  $V_{5V\_Ripple}$ , 40 mV / div., 10 ms / div.  
 CH4:  $V_{12V\_Ripple}$ , 40 mV / div., 10 ms / div.  
 Zoom: 10  $\mu$ s / div.  
 5 V Output Ripple = 31.621 mV.  
 12 V Output Ripple = 47.431 mV.

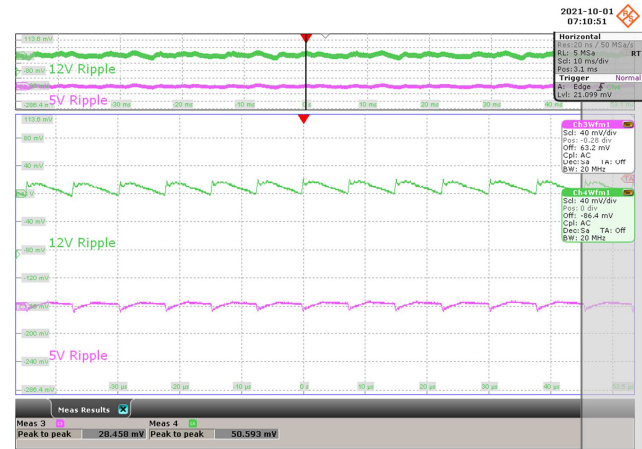


Figure 109 – 115 VAC 60 Hz.

CH3:  $V_{5V\_Ripple}$ , 40 mV / div., 10 ms / div.  
 CH4:  $V_{12V\_Ripple}$ , 40 mV / div., 10 ms / div.  
 Zoom: 10  $\mu$ s / div.  
 5 V Output Ripple = 28.458 mV.  
 12 V Output Ripple = 50.593 mV.

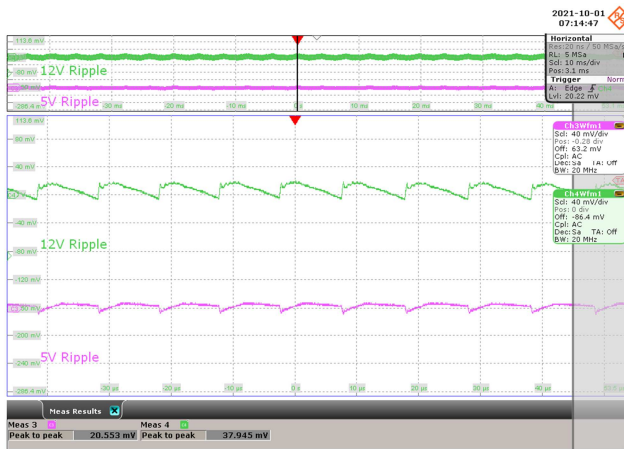


Figure 110 – 230 VAC 50 Hz.

CH3:  $V_{5V\_Ripple}$ , 40 mV / div., 10 ms / div.  
 CH4:  $V_{12V\_Ripple}$ , 40 mV / div., 10 ms / div.  
 Zoom: 10  $\mu$ s / div.  
 5 V Output Ripple = 20.553 mV.  
 12 V Output Ripple = 37.945 mV.

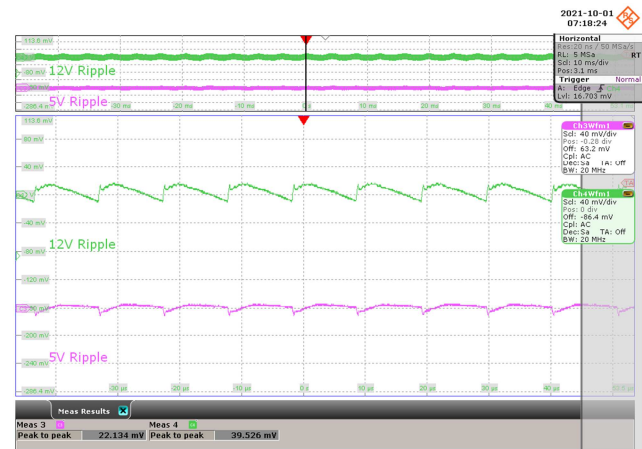
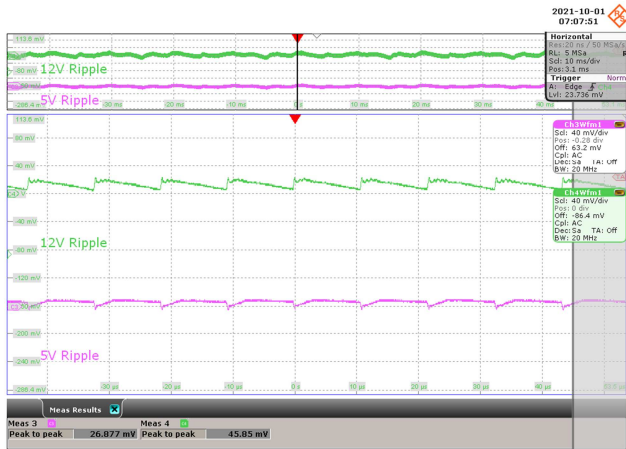


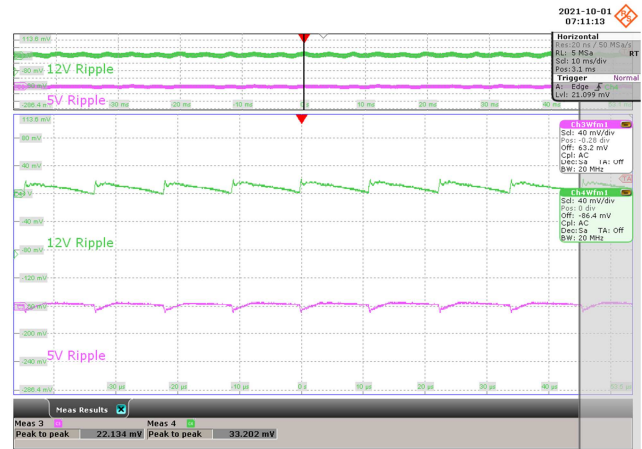
Figure 111 – 265 VAC 50 Hz.

CH3:  $V_{5V\_Ripple}$ , 40 mV / div., 10 ms / div.  
 CH4:  $V_{12V\_Ripple}$ , 40 mV / div., 10 ms / div.  
 Zoom: 10  $\mu$ s / div.  
 5 V Output Ripple = 22.134 mV.  
 12 V Output Ripple = 39.526 mV.

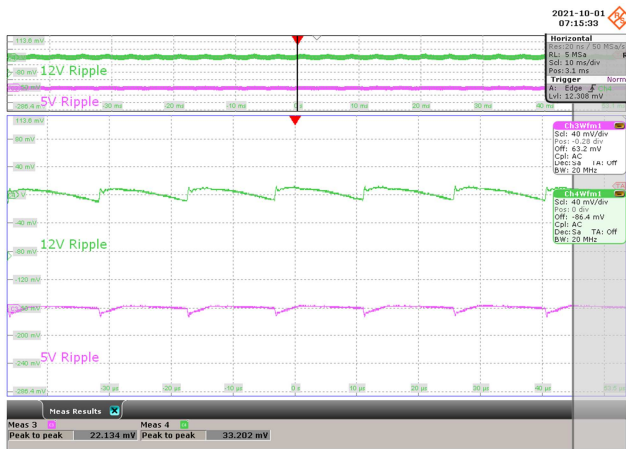
11.5.2.3 50% Load Condition



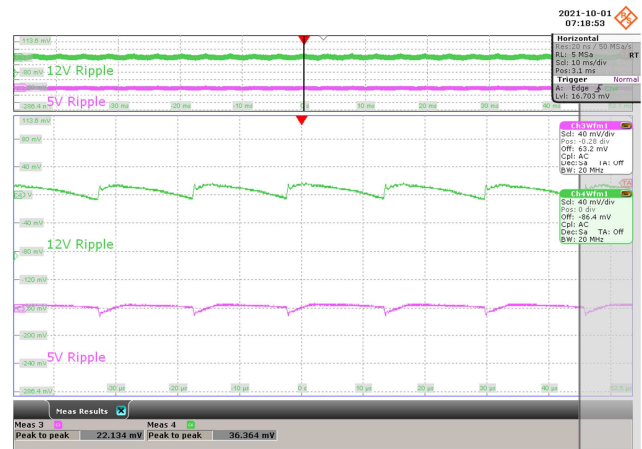
**Figure 112** – 90 VAC 60 Hz.  
 CH3:  $V_{5V\_Ripple}$ , 40 mV / div., 10 ms / div.  
 CH4:  $V_{12V\_Ripple}$ , 40 mV / div., 10 ms / div.  
 Zoom: 10  $\mu$ s / div.  
 5 V Output Ripple = 26.877 mV.  
 12 V Output Ripple = 45.85 mV.



**Figure 113** – 115 VAC 60 Hz.  
 CH3:  $V_{5V\_Ripple}$ , 40 mV / div., 10 ms / div.  
 CH4:  $V_{12V\_Ripple}$ , 40 mV / div., 10 ms / div.  
 Zoom: 10  $\mu$ s / div.  
 5 V Output Ripple = 22.134 mV.  
 12 V Output Ripple = 33.202 mV.

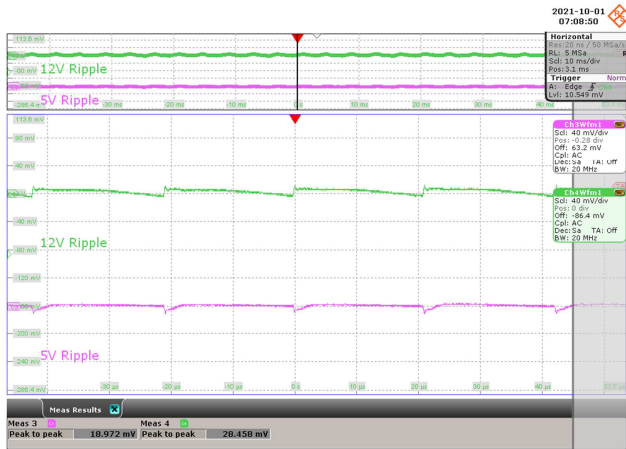


**Figure 114** – 230 VAC 50 Hz.  
 CH3:  $V_{5V\_Ripple}$ , 40 mV / div., 10 ms / div.  
 CH4:  $V_{12V\_Ripple}$ , 40 mV / div., 10 ms / div.  
 Zoom: 10  $\mu$ s / div.  
 5 V Output Ripple = 22.134 mV.  
 12 V Output Ripple = 33.202 mV.

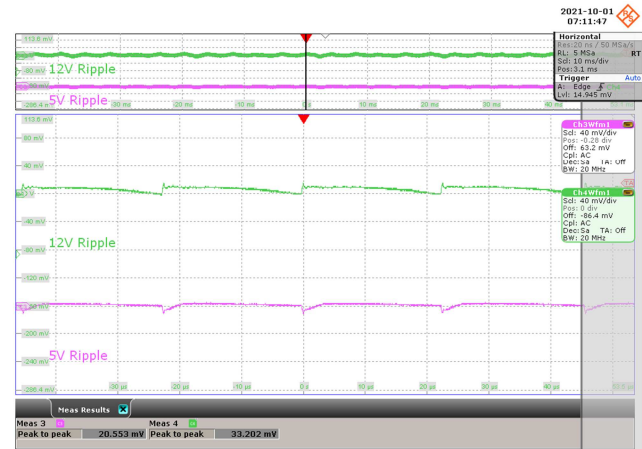


**Figure 115** – 265 VAC 50 Hz.  
 CH3:  $V_{5V\_Ripple}$ , 40 mV / div., 10 ms / div.  
 CH4:  $V_{12V\_Ripple}$ , 40 mV / div., 10 ms / div.  
 Zoom: 10  $\mu$ s / div.  
 5 V Output Ripple = 22.134 mV.  
 12 V Output Ripple = 36.364 mV.

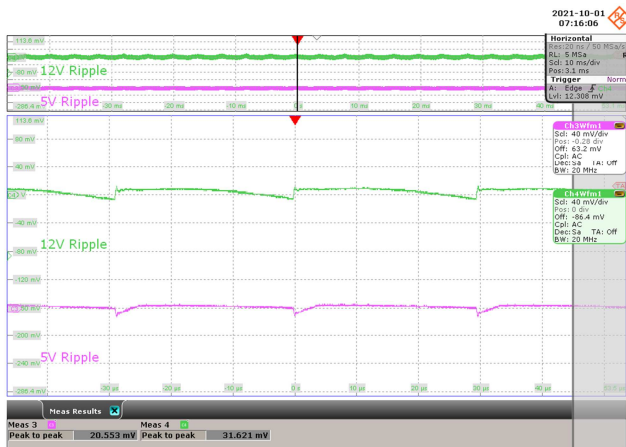
11.5.2.4 25% Load Condition



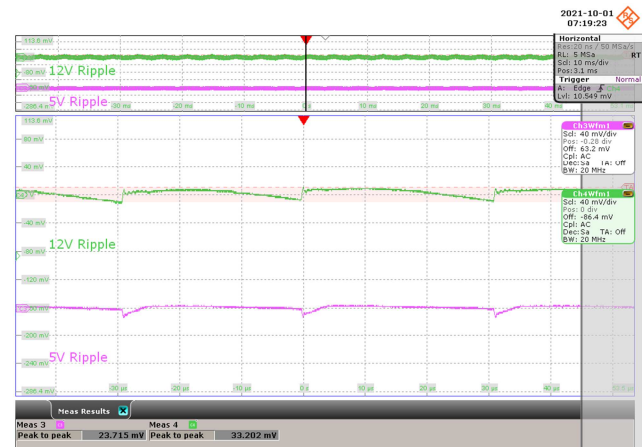
**Figure 116** – 90 VAC 60 Hz.  
 CH3:  $V_{5V\_Ripple}$ , 40 mV / div., 10 ms / div.  
 CH4:  $V_{12V\_Ripple}$ , 40 mV / div., 10 ms / div.  
 Zoom: 10  $\mu$ s / div.  
 5 V Output Ripple = 18.972 mV.  
 12 V Output Ripple = 28.458 mV.



**Figure 117** – 115 VAC 60 Hz.  
 CH3:  $V_{5V\_Ripple}$ , 40 mV / div., 10 ms / div.  
 CH4:  $V_{12V\_Ripple}$ , 40 mV / div., 10 ms / div.  
 Zoom: 10  $\mu$ s / div.  
 5 V Output Ripple = 20.553 mV.  
 12 V Output Ripple = 33.202 mV.



**Figure 118** – 230 VAC 50 Hz.  
 CH3:  $V_{5V\_Ripple}$ , 40 mV / div., 10 ms / div.  
 CH4:  $V_{12V\_Ripple}$ , 40 mV / div., 10 ms / div.  
 Zoom: 10  $\mu$ s / div.  
 5 V Output Ripple = 20.553 mV.  
 12 V Output Ripple = 31.621 mV.



**Figure 119** – 265 VAC 50 Hz.  
 CH3:  $V_{5V\_Ripple}$ , 40 mV / div., 10 ms / div.  
 CH4:  $V_{12V\_Ripple}$ , 40 mV / div., 10 ms / div.  
 Zoom: 10  $\mu$ s / div.  
 5 V Output Ripple = 23.715 mV.  
 12 V Output Ripple = 33.202 mV.

11.5.2.5 10% Load Condition

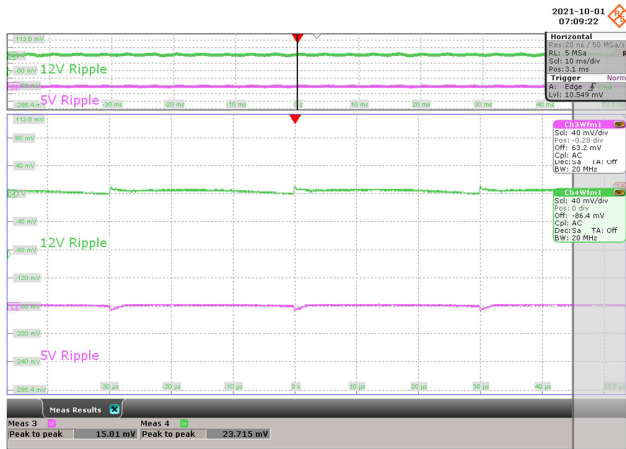


Figure 120 – 90 VAC 60 Hz.

CH3:  $V_{5V\_Ripple}$ , 40 mV / div., 10 ms / div.  
 CH4:  $V_{12V\_Ripple}$ , 40 mV / div., 10 ms / div.  
 Zoom: 10  $\mu$ s / div.  
 5 V Output Ripple = 15.81 mV.  
 12 V Output Ripple = 23.715 mV.

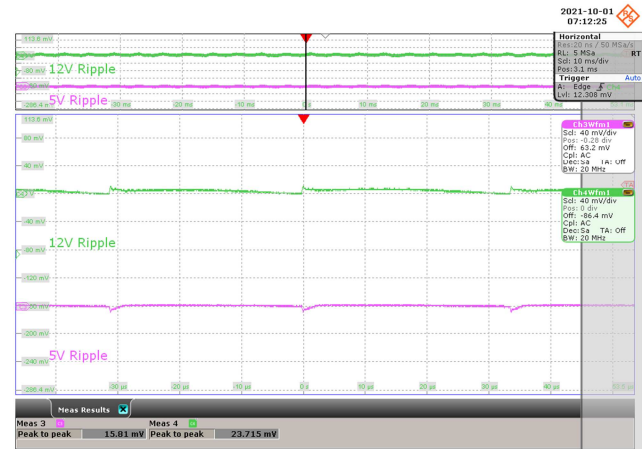


Figure 121 – 115 VAC 60 Hz.

CH3:  $V_{5V\_Ripple}$ , 40 mV / div., 10 ms / div.  
 CH4:  $V_{12V\_Ripple}$ , 40 mV / div., 10 ms / div.  
 Zoom: 10  $\mu$ s / div.  
 5 V Output Ripple = 15.81 mV.  
 12 V Output Ripple = 23.715 mV.

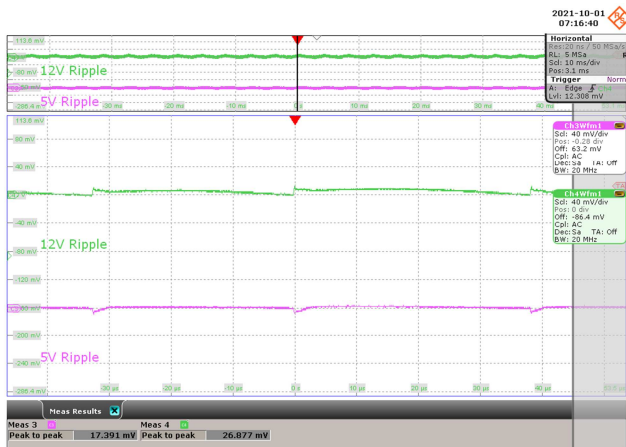


Figure 122 – 230 VAC 50 Hz.

CH3:  $V_{5V\_Ripple}$ , 40 mV / div., 10 ms / div.  
 CH4:  $V_{12V\_Ripple}$ , 40 mV / div., 10 ms / div.  
 Zoom: 10  $\mu$ s / div.  
 5 V Output Ripple = 17.391 mV.  
 12 V Output Ripple = 26.877 mV.

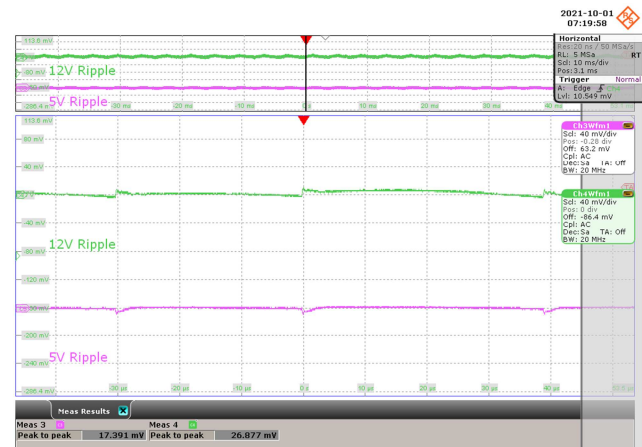


Figure 123 – 265 VAC 50 Hz.

CH3:  $V_{5V\_Ripple}$ , 40 mV / div., 10 ms / div.  
 CH4:  $V_{12V\_Ripple}$ , 40 mV / div., 10 ms / div.  
 Zoom: 10  $\mu$ s / div.  
 5 V Output Ripple = 17.391 mV.  
 12 V Output Ripple = 26.877 mV.

11.5.3 12 V Output Ripple Voltage Graph from 10% - 100%

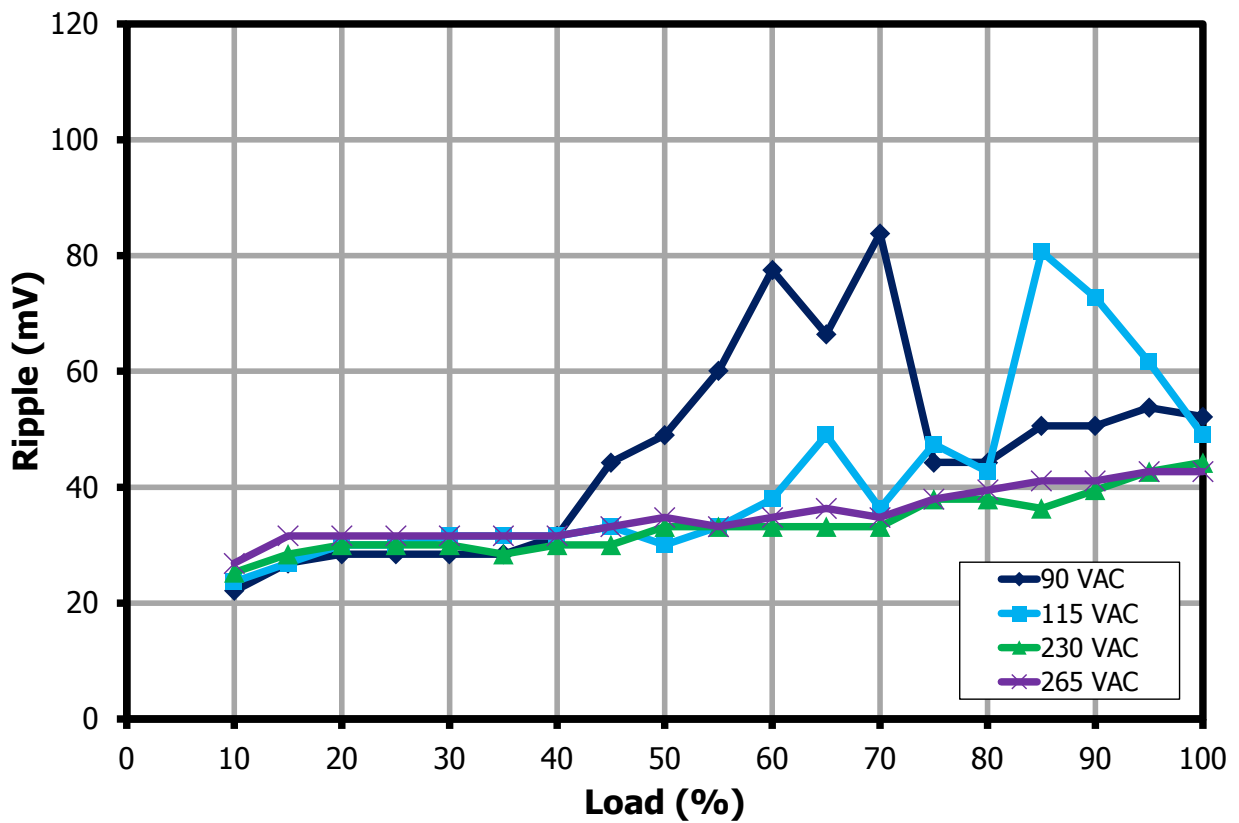


Figure 124 – 12 V Voltage Ripple (Measured at PCB End at Room Temperature).

11.5.4 5 V Output Ripple Voltage Graph from 10% - 100%

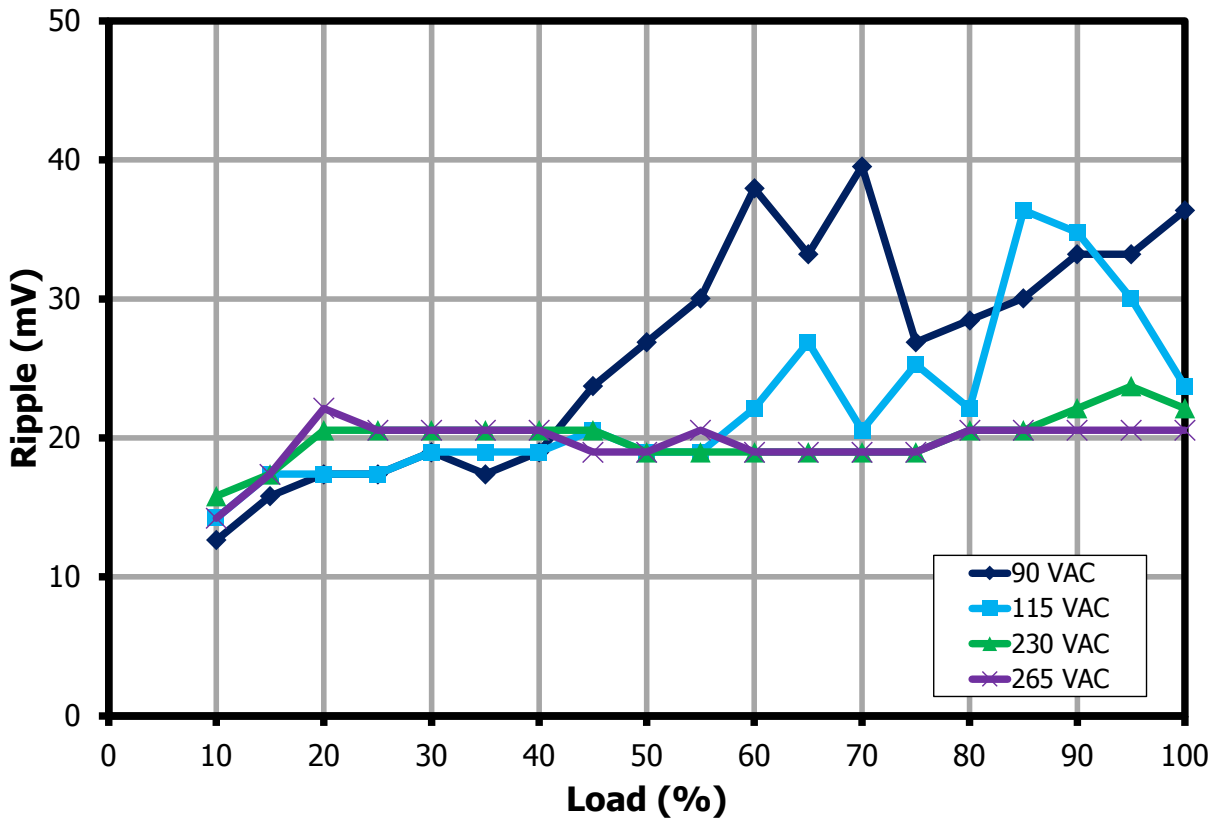
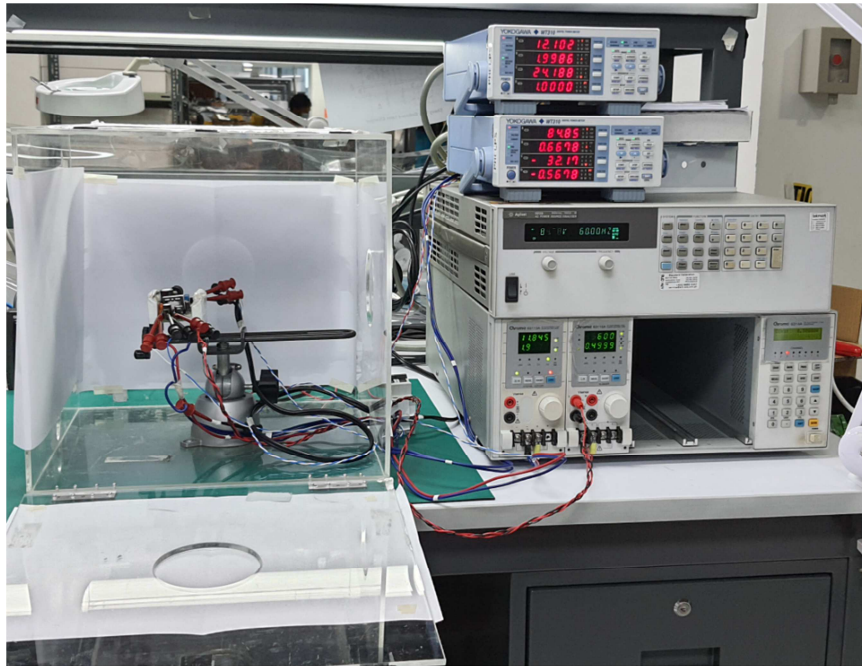


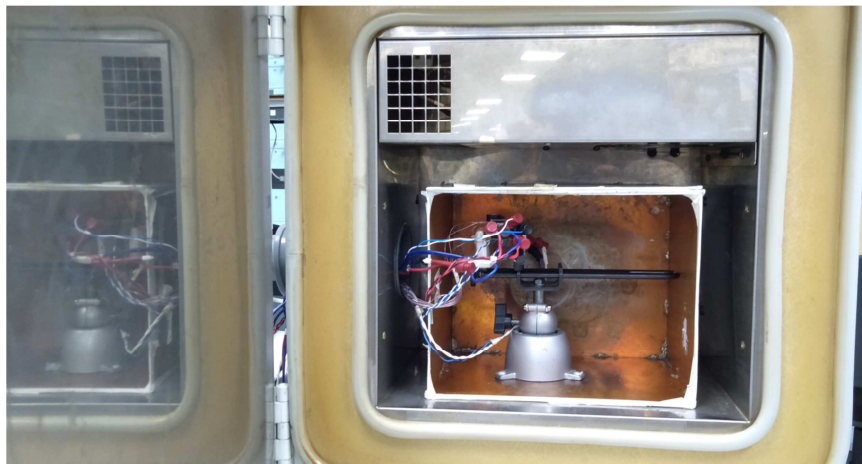
Figure 125 – 5 V Voltage Ripple (Measured at PCB End at Room Temperature).



## 12 Thermal Performance



**Figure 126** – Thermal Performance Set-up Using an Acrylic Box at Room Temperature.



**Figure 127** – Thermal Performance Set-up Using Thermal Chamber.

12.1.1 90 VAC Full Load at Room Temperature

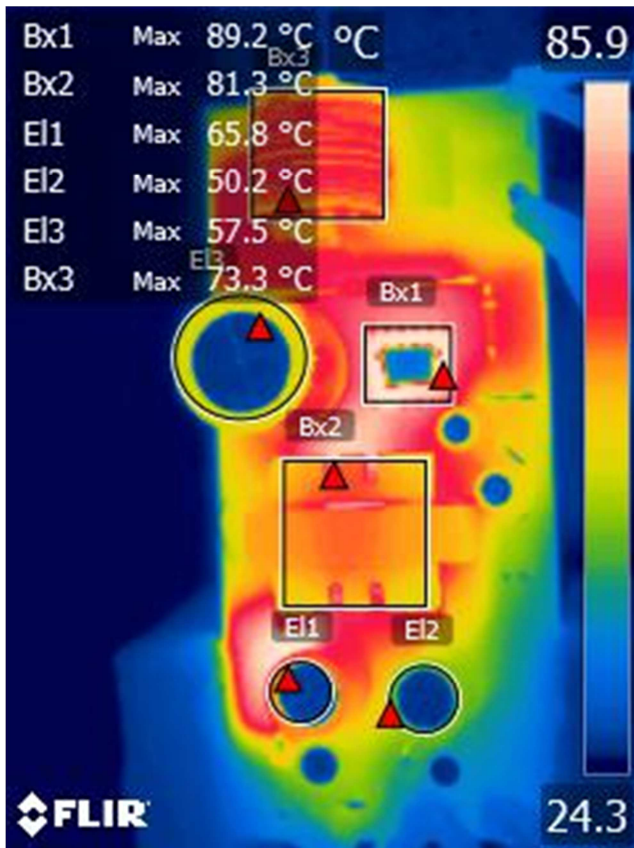


Figure 128 – 90 VAC 60 Hz. Thermals Top.

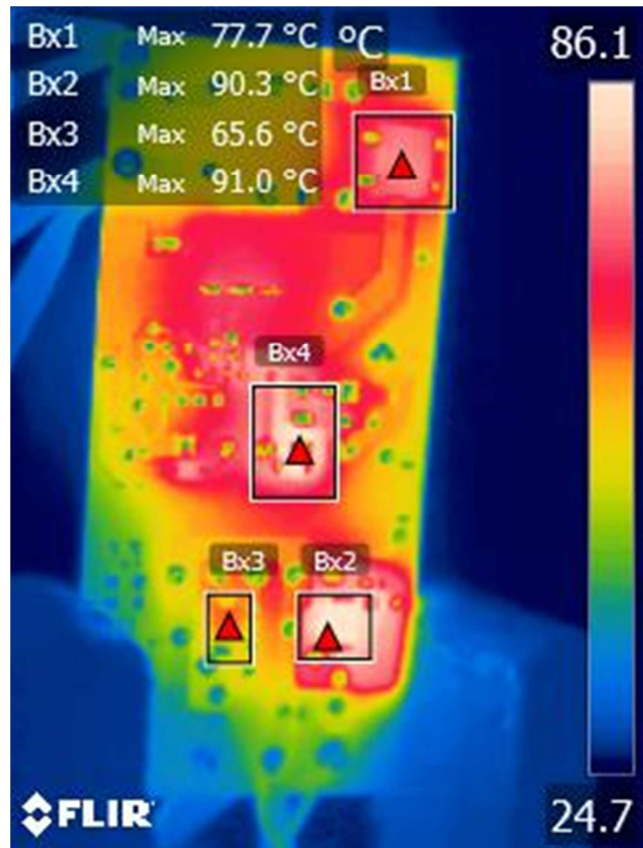


Figure 129 – 90 VAC 60 Hz. Thermals Bottom.

Component	Temperature (°C)
Ambient	24.3
TOP267VG (U1)	89.2
Transformer (T1)	81.3
12 V Output Capacitor (C9)	65.8
5 V Output Capacitor (C12)	50.2
Input Capacitor (C2)	57.5
CMC (L1)	73.3
Bridge (BR1)	77.7
12 V FreeWheeling Diode (D4)	90.3
5 V FreeWheeling Diode (D5)	65.6
Snubber Resistor (R4)	91



12.1.2 265 VAC Full Load at Room Temperature

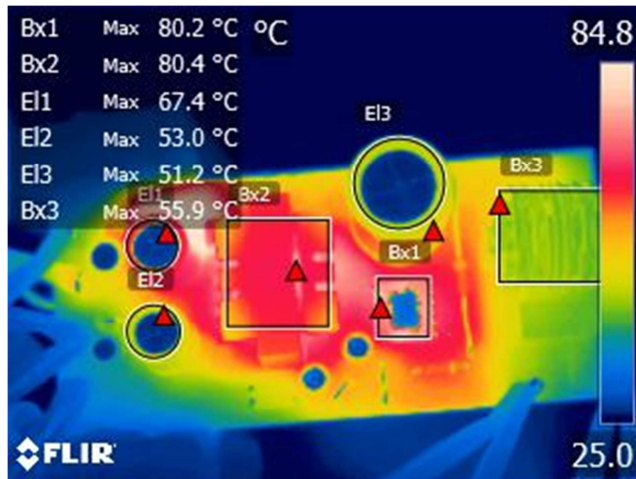


Figure 130 – 265 VAC 60 Hz. Thermals Top.

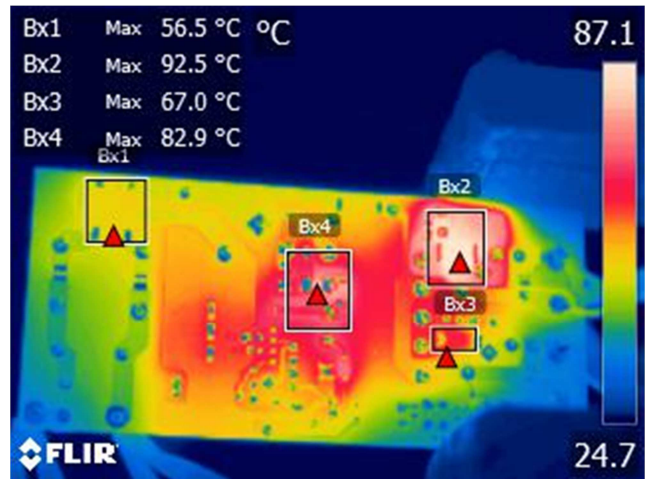


Figure 131 – 265 VAC 60 Hz. Thermals Bottom.

Component	Temperature (°C)
Ambient	25
TOP267VG (U1)	80.2
Transformer (T1)	80.4
12 V Output Capacitor (C9)	67.4
5 V Output Capacitor (C12)	53
Input Capacitor (C2)	51.2
CMC (L1)	55.9
Bridge (BR1)	56.5
12 V FreeWheeling Diode (D4)	92.5
5 V FreeWheeling Diode (D5)	67
Snubber Resistor (R4)	82.9

## 12.1.1.3 90 VAC Full Load at 40 °C Ambient (Thermal Chamber)

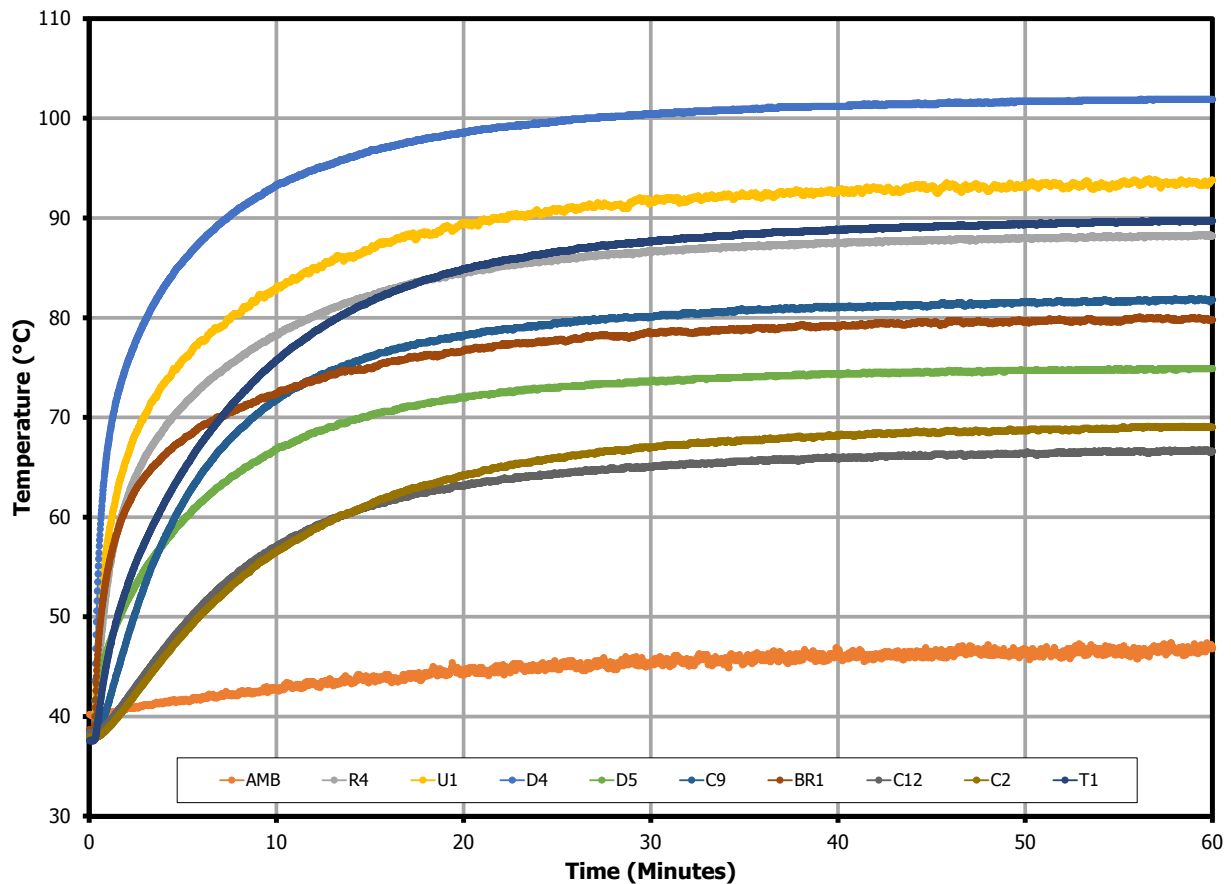


Figure 132 – 90 VAC 60 Hz. Thermals at 40 °C Ambient.

Component	Temperature (°C)
Ambient	46.9
TOP267VG (U1)	93.5
Transformer (T1)	89.8
12 V Output Capacitor (C9)	82
5 V Output Capacitor (C12)	66.8
Input Capacitor (C2)	69
Bridge (BR1)	80
12 V FreeWheeling Diode (D4)	102
5 V FreeWheeling Diode (D5)	74.9
Snubber Resistor (R4)	88.4

12.1.4 265 VAC Full Load at 40 °C Ambient (Thermal Chamber)

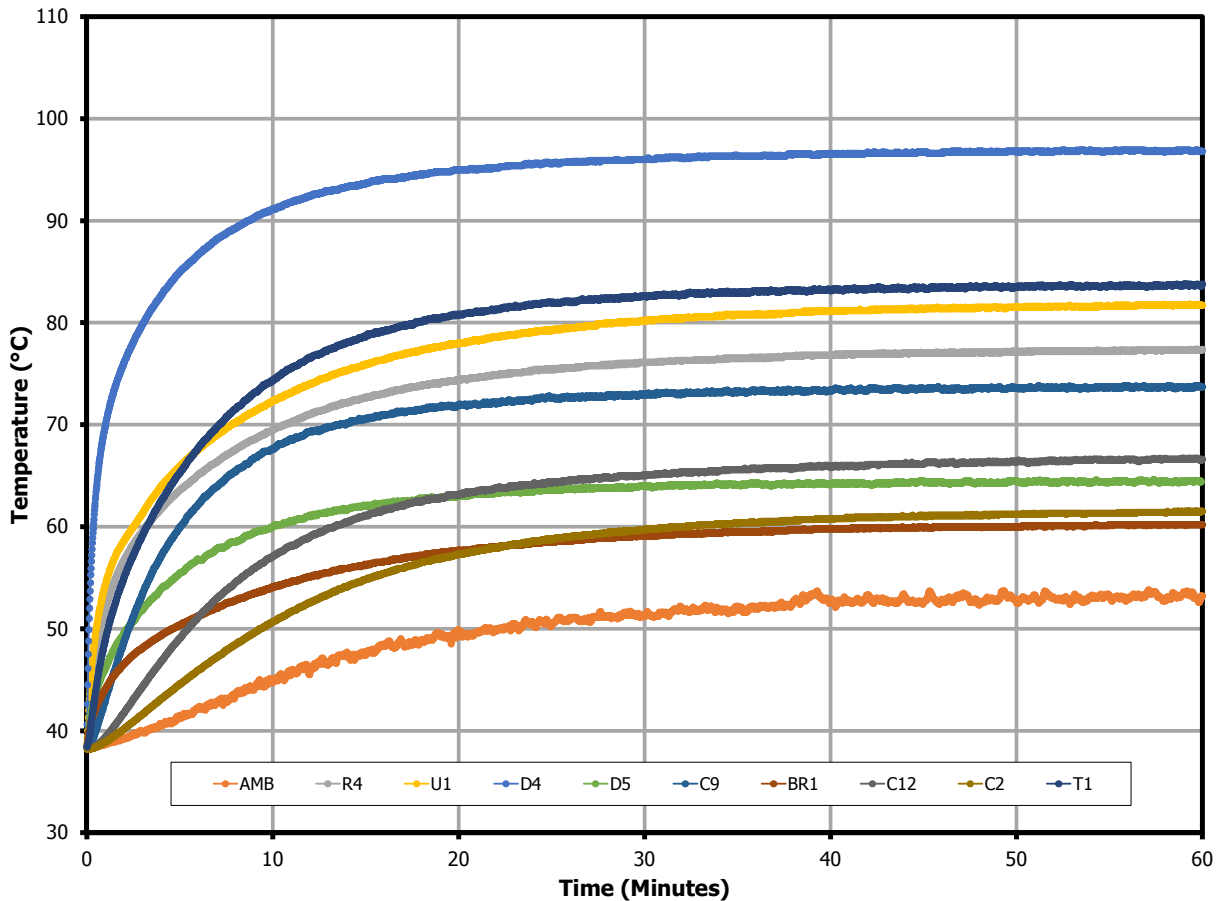


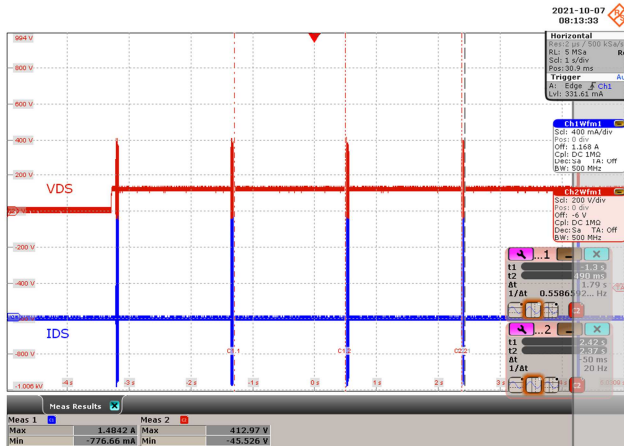
Figure 133 – 265 VAC 60 Hz. Thermals at 40 °C Ambient.

Component	Temperature (°C)
Ambient	53.2
TOP267VG (U1)	81.7
Transformer (T1)	83.8
12 V Output Capacitor (C9)	73.7
5 V Output Capacitor (C12)	66.8
Input Capacitor (C2)	61.5
Bridge (BR1)	60.2
12 V FreeWheeling Diode (D4)	96.8
5 V FreeWheeling Diode (D5)	64.4
Snubber Resistor (R4)	77.4

## 13 Fault Condition

### 13.1 Output Short-Circuit Protection

5 V and 12 V output were shorted to 0 V simultaneously



**Figure 134** – 90 VAC 60 Hz. Output Short.

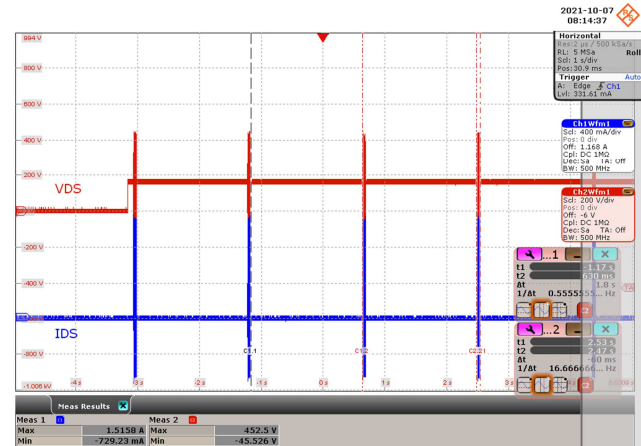
CH1:  $I_{DS}$ , 400 mA / div., 1 s / div.

CH2:  $V_{DS}$ , 200 V / div., 1 s / div.

$V_{DS(MAX)} = 412.97$  V.

$I_{DS(MAX)} = 1.4842$  A.

$t_{AR\_ON} = 50$  ms,  $t_{AR\_OFF} = 1.79$  s.



**Figure 135** – 115 VAC 60 Hz Output Short.

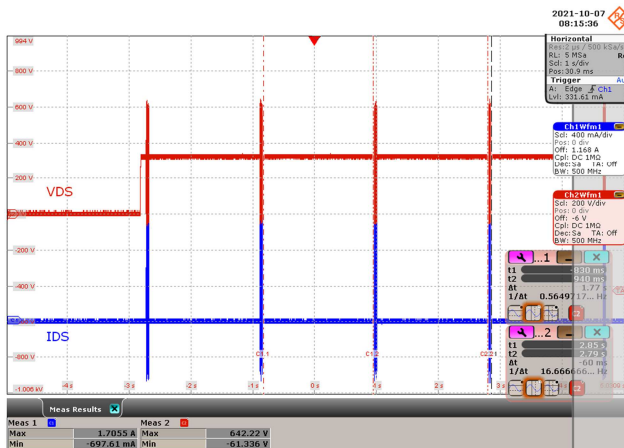
CH1:  $I_{DS}$ , 400 mA / div., 1 s / div.

CH2:  $V_{DS}$ , 200 V / div., 1 s / div.

$V_{DS(MAX)} = 452.5$  V.

$I_{DS(MAX)} = 1.5158$  A.

$t_{AR\_ON} = 60$  ms,  $t_{AR\_OFF} = 1.8$  s.



**Figure 136** – 230 VAC 60 Hz. Output Short.

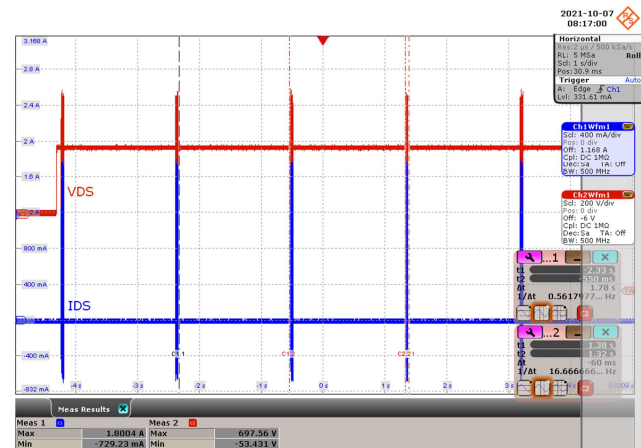
CH1:  $I_{DS}$ , 400 mA / div., 1 s / div.

CH2:  $V_{DS}$ , 200 V / div., 1 s / div.

$V_{DS(MAX)} = 642.22$  V.

$I_{DS(MAX)} = 1.7055$  A.

$t_{AR\_ON} = 60$  ms,  $t_{AR\_OFF} = 1.77$  s.



**Figure 137** – 265 VAC 60 Hz. Output Short.

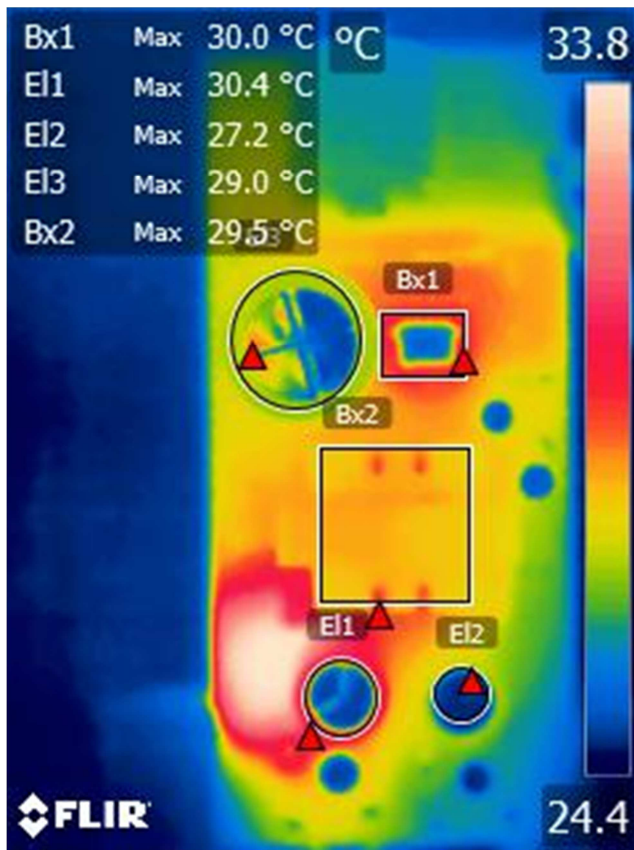
CH1:  $I_{DS}$ , 400 mA / div., 1 s / div.

CH2:  $V_{DS}$ , 200 V / div., 1 s / div.

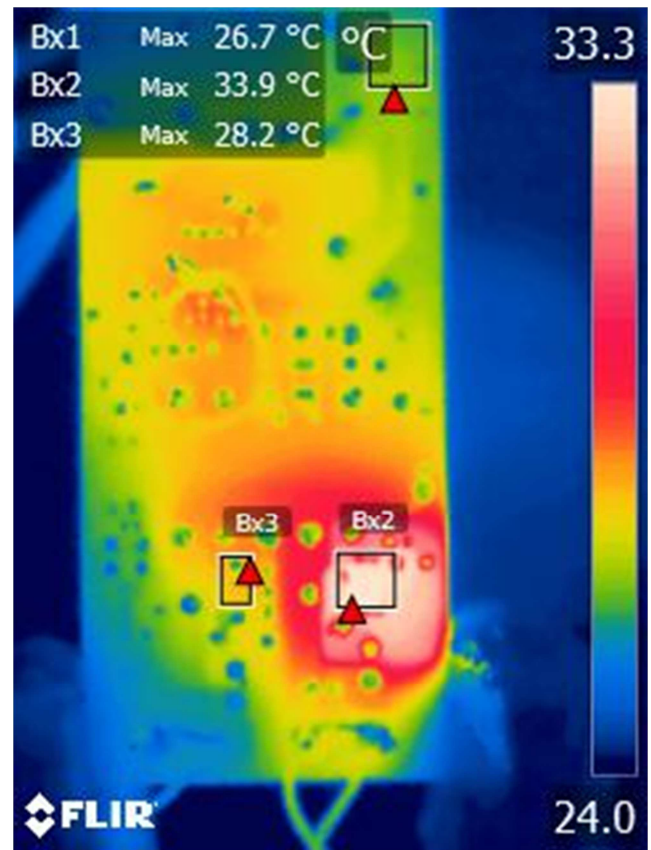
$V_{DS(MAX)} = 697.56$  V.

$I_{DS(MAX)} = 1.8004$  A.

$t_{AR\_ON} = 60$  ms,  $t_{AR\_OFF} = 1.78$  s.



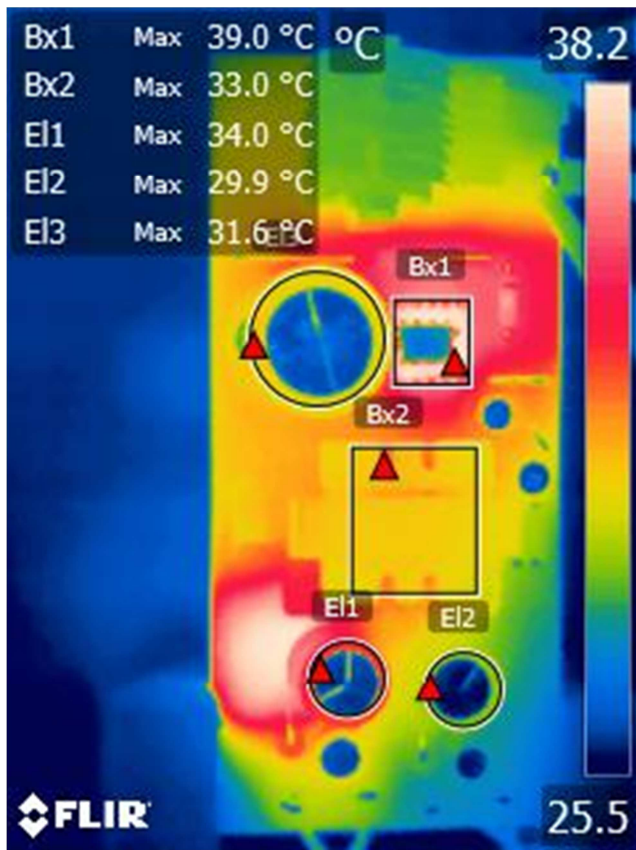
**Figure 138** – 90 VAC 60 Hz. Output Short Thermals Top.



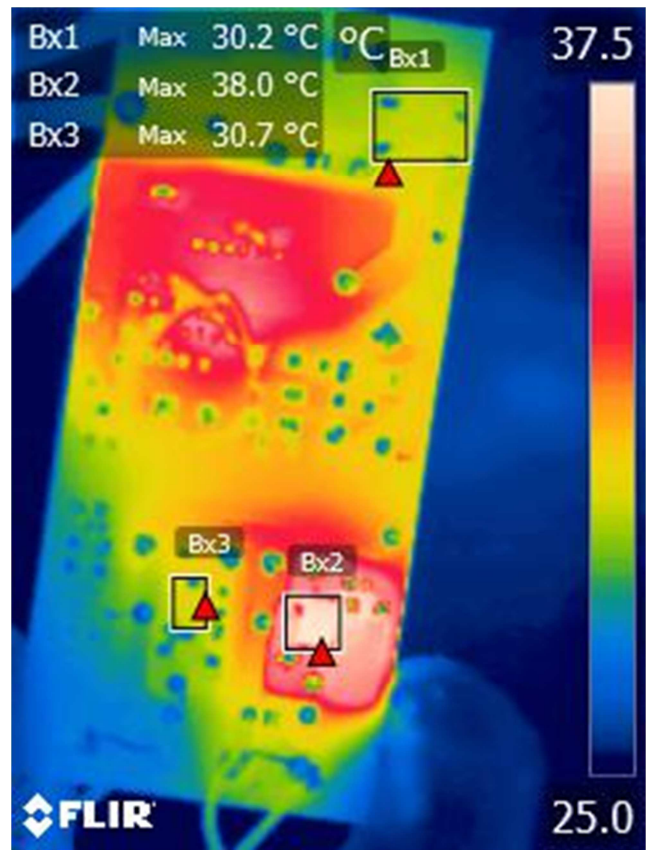
**Figure 139** – 90 VAC 60 Hz. Output Short Thermals Bottom.

Component	Temperature (°C)
Ambient	24.4
TOP267VG (U1)	30
Transformer (T1)	29.5
12 V Output Capacitor (C9)	30.4
5 V Output Capacitor (C12)	27.2
Input Capacitor (C2)	29
Bridge (BR1)	26.7
12 V Freewheeling Diode (D4)	33.9
5 V Freewheeling Diode (D5)	28.2





**Figure 140** – 265 VAC 60 Hz. Output Short Thermals Top.

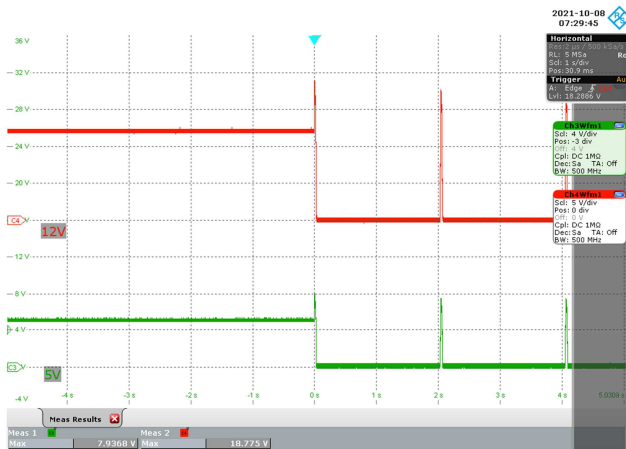


**Figure 141** – 265 VAC 60 Hz. Output Short Thermals Bottom.

Component	Temperature (°C)
Ambient	25.5
TOP267VG (U1)	39
Transformer (T1)	33
12 V Output Capacitor (C9)	34
5 V Output Capacitor (C12)	29.9
Input Capacitor (C2)	31.6
Bridge (BR1)	30.2
12 V Freewheeling Diode (D4)	38
5 V Freewheeling Diode (D5)	30.7

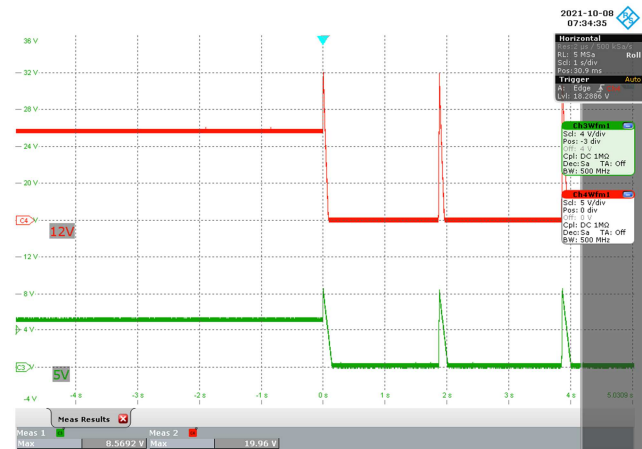
### 13.2 Output Overvoltage Protection

Output overvoltage condition was simulated by shorting LED of the optocoupler (U2) with output at full load and minimum load. Overvoltage protection was implemented by primary-side output overvoltage circuit VR2, D3, and R5.



**Figure 142** – 90 VAC 60 Hz. Full Load.

CH3:  $V_{5V}$ , 4 V / div., 1 s / div.  
 CH4:  $V_{12V}$ , 5 V / div., 1 s / div.  
 $12 V_{OUT}$ :  $V_{MAX}$ : 18.775 V.  
 $5 V_{OUT}$ :  $V_{MAX}$ : 7.9368 V.



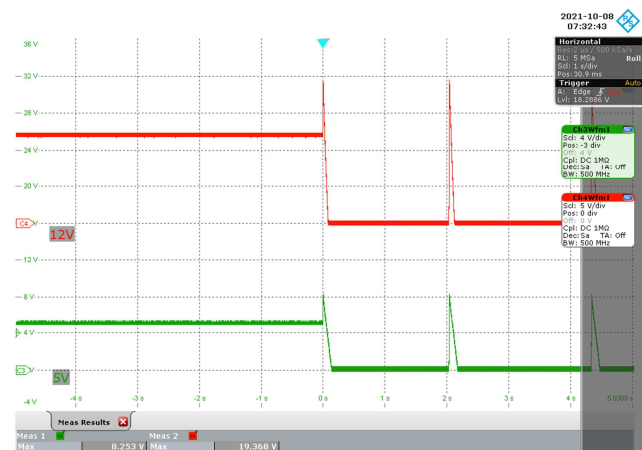
**Figure 143** – 90 VAC 60 Hz Min Load.

CH3:  $V_{5V}$ , 4 V / div., 1 s / div.  
 CH4:  $V_{12V}$ , 5 V / div., 1 s / div.  
 $12 V_{OUT}$ :  $V_{MAX}$ : 19.96 V.  
 $5 V_{OUT}$ :  $V_{MAX}$ : 8.5692 V.



**Figure 144** – 265 VAC 60 Hz. Full Load.

CH3:  $V_{5V}$ , 4 V / div., 1 s / div.  
 CH4:  $V_{12V}$ , 5 V / div., 1 s / div.  
 $12 V_{OUT}$ :  $V_{MAX}$ : 18.972 V.  
 $5 V_{OUT}$ :  $V_{MAX}$ : 7.9447 V.



**Figure 145** – 265 VAC 60 Hz. Min Load.

CH3:  $V_{5V}$ , 4 V / div., 1 s / div.  
 CH4:  $V_{12V}$ , 5 V / div., 1 s / div.  
 $12 V_{OUT}$ :  $V_{MAX}$ : 19.368 V.  
 $5 V_{OUT}$ :  $V_{MAX}$ : 8.253 V.

13.3 **Over Temperature Protection**

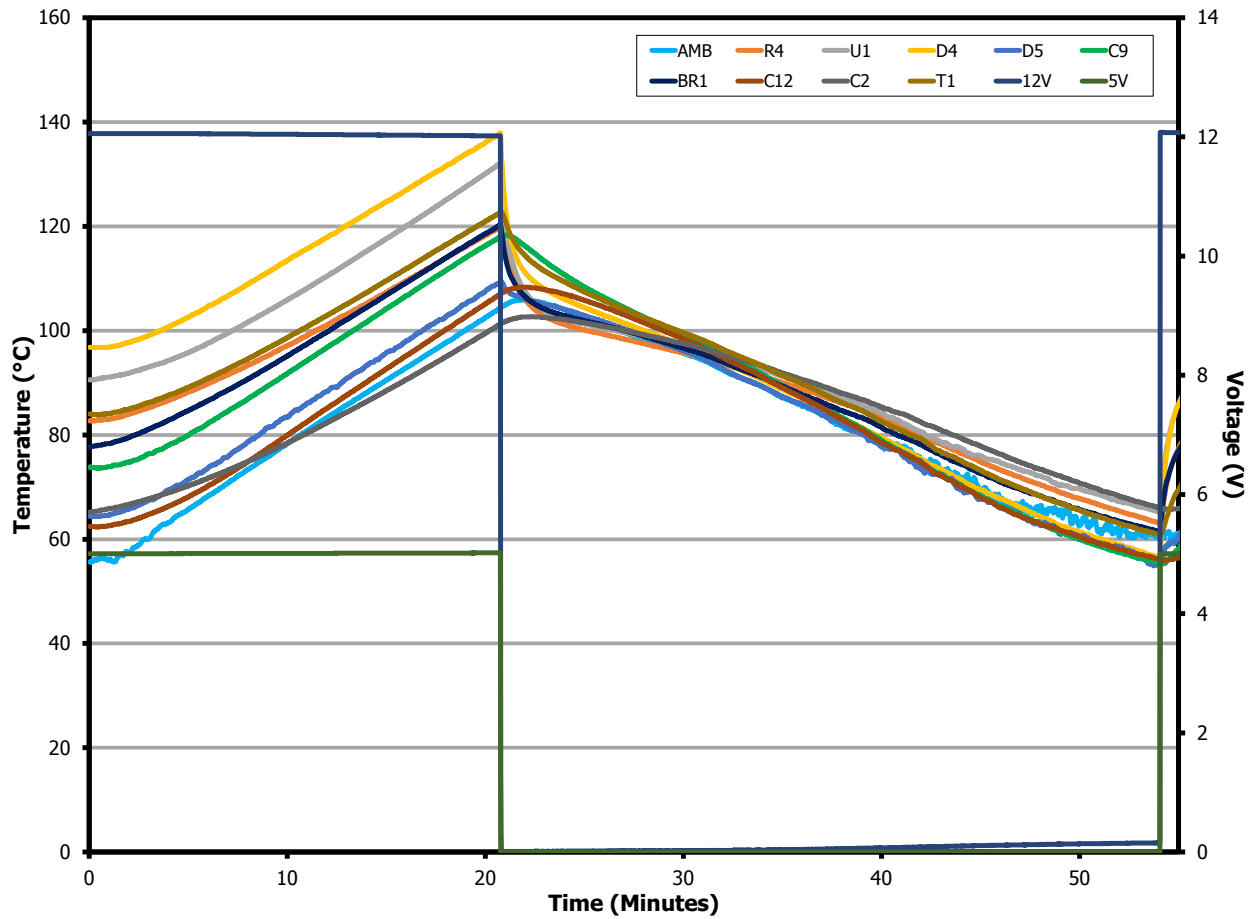


Figure 146 – 90 VAC 60 Hz. Full Load OTP.



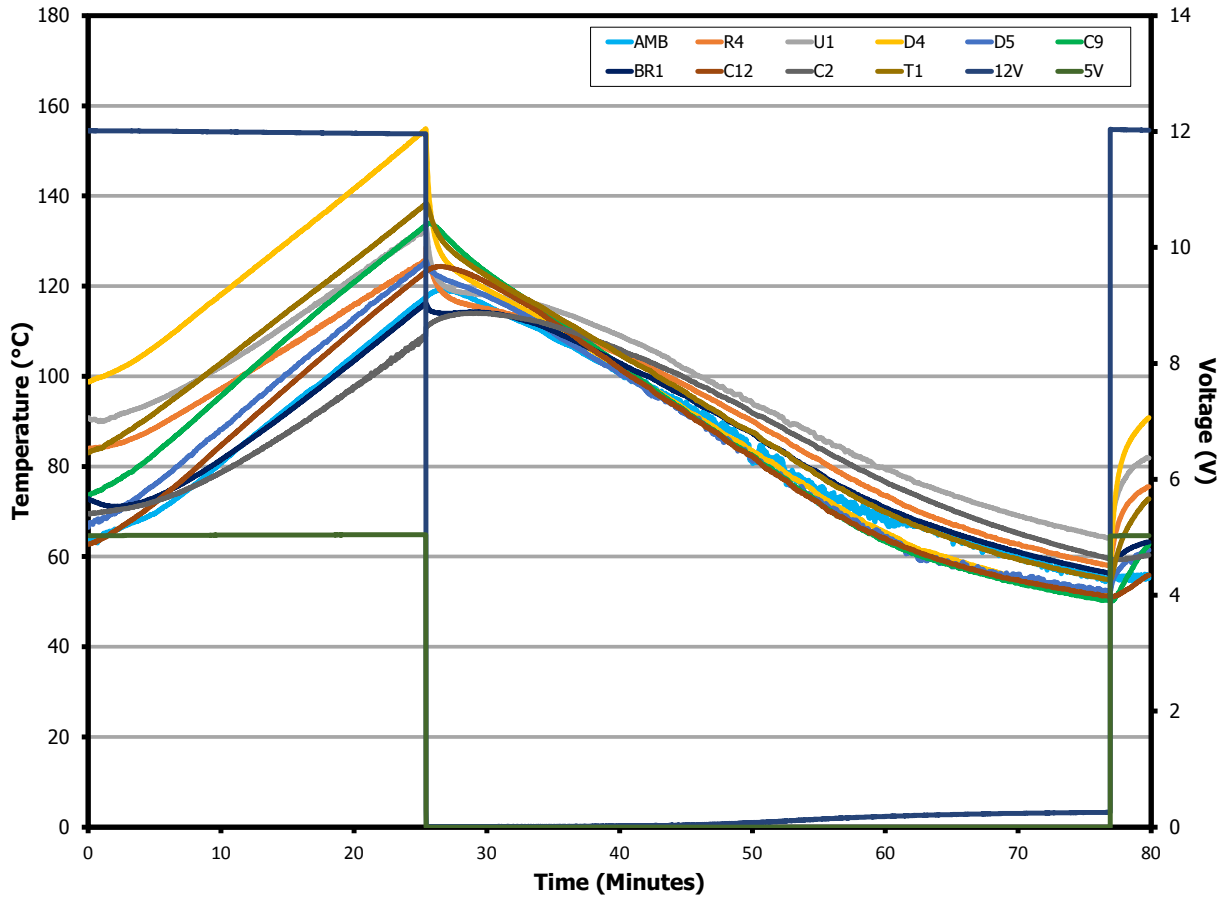


Figure 147 – 265 VAC 60 Hz. Full Load OTP.

Input (VAC)	IC Temperature (°C)	
	OTP Shutdown	Recover
90	132.1	65.3
265	134.3	64.1

## 14 Conducted EMI

Conducted emissions tests were performed at 115 VAC and 230 VAC at full load (12 V 2 A, 5 V 0.5 A). Measurements were taken with floating ground and grounded output.

### 14.1 Test Set-up Equipment

#### 14.1.1 Equipment and Load Used

1. Rohde and Schwarz ENV216 two line V-network.
2. Rohde and Schwarz ESRP EMI test receiver.
3. Yokogawa WT310E digital power meter.
4. Chroma measurement test fixture A662003.
5. Input voltage set at 115 VAC and 230 VAC.
6. 12 V RLOAD resistance is 6 ohms.
7. 5 V RLOAD resistance is 10 ohms.

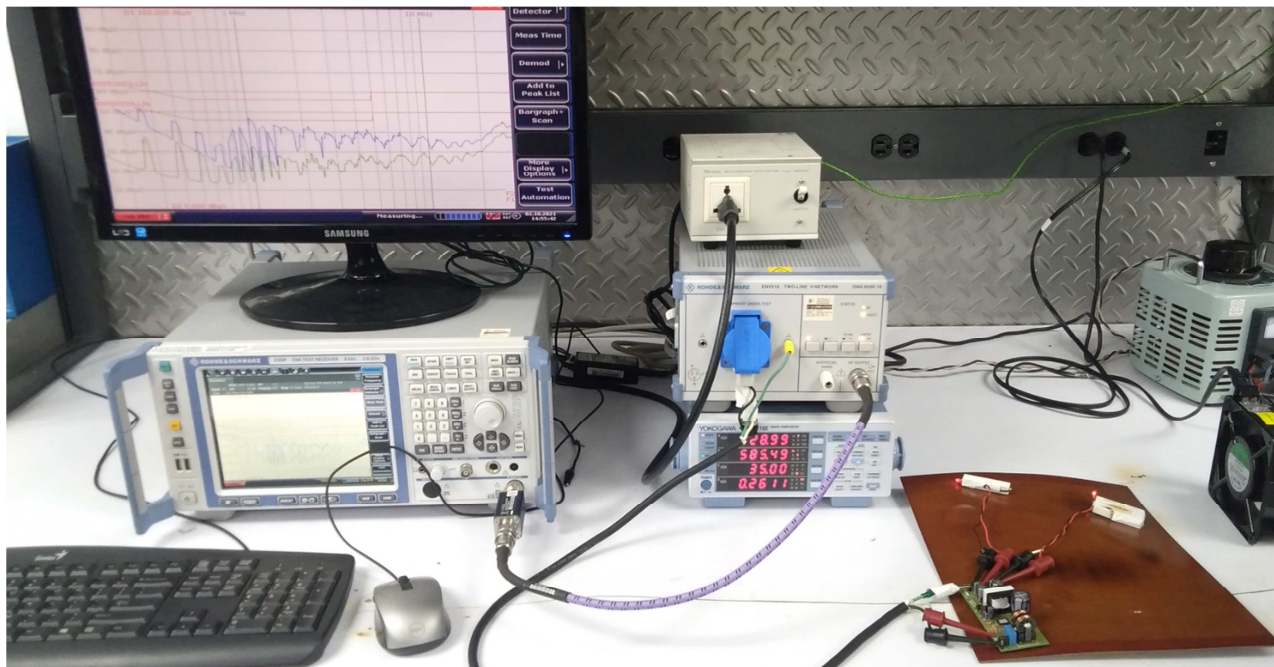
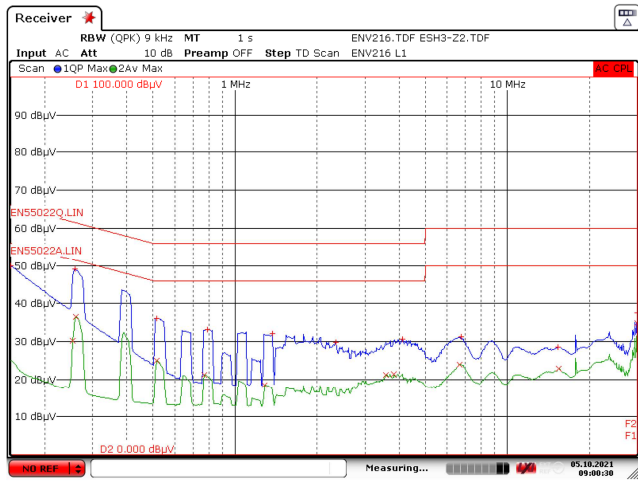


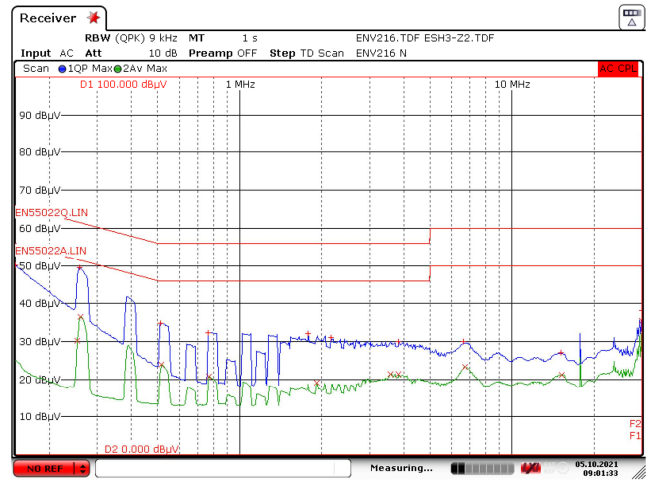
Figure 148 – EMI Test Set-up.

### 14.2 Output Float



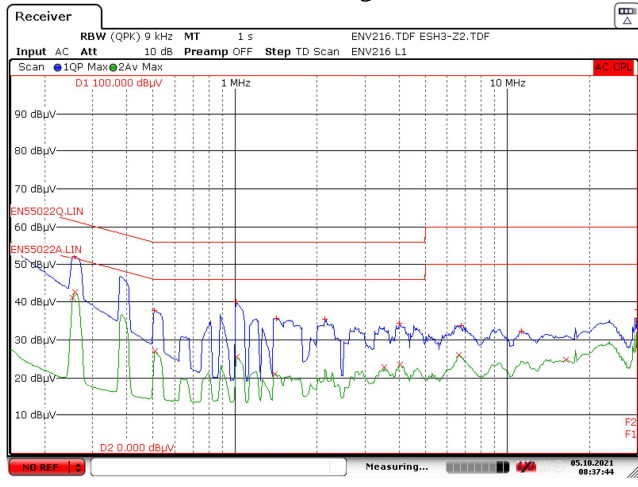
Date: 5.OCT.2021 09:00:31

**Figure 149** – 115 VAC 60 Hz.  
Line with Floating Ground.



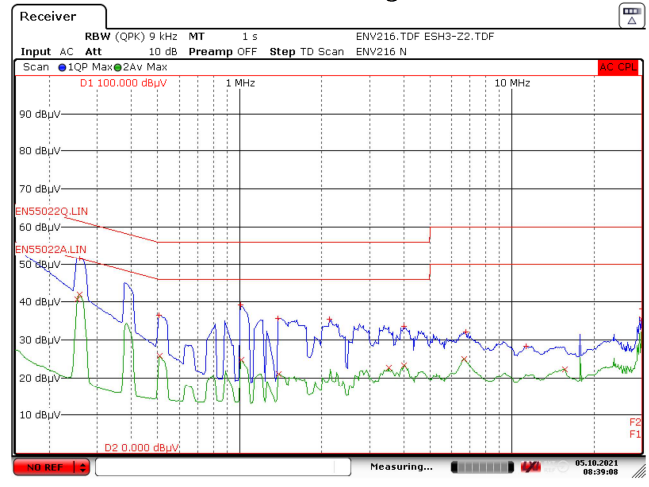
Date: 5.OCT.2021 09:01:34

**Figure 150** – 115 VAC 60 Hz.  
Neutral with Floating Ground.



Date: 5.OCT.2021 08:37:43

**Figure 151** – 230 VAC 60 Hz.  
Line with Floating Ground.

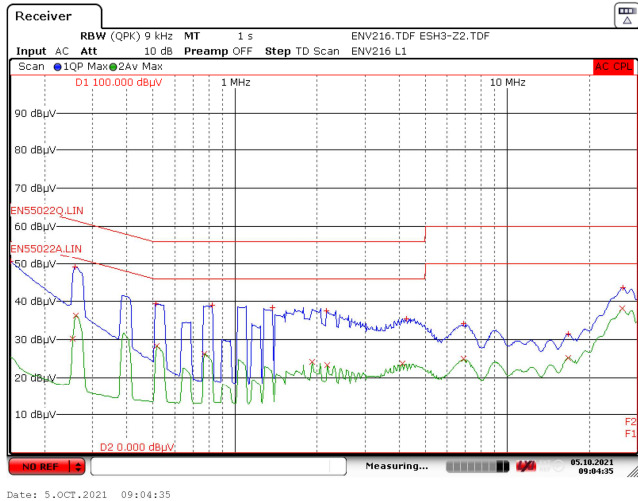


Date: 5.OCT.2021 08:39:08

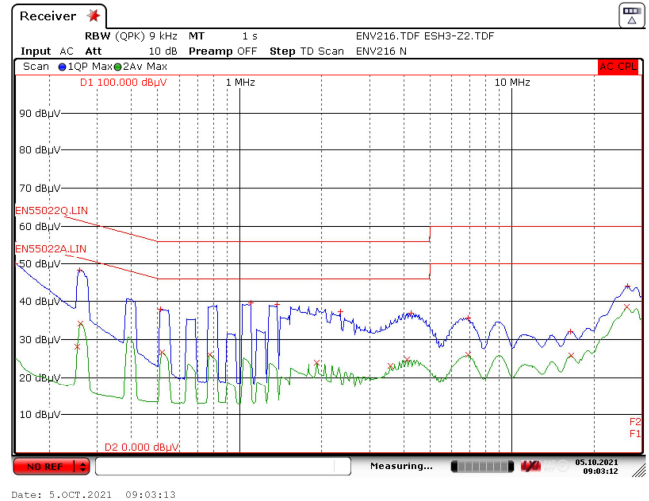
**Figure 152** – 230 VAC 60 Hz.  
Neutral with Floating Ground.



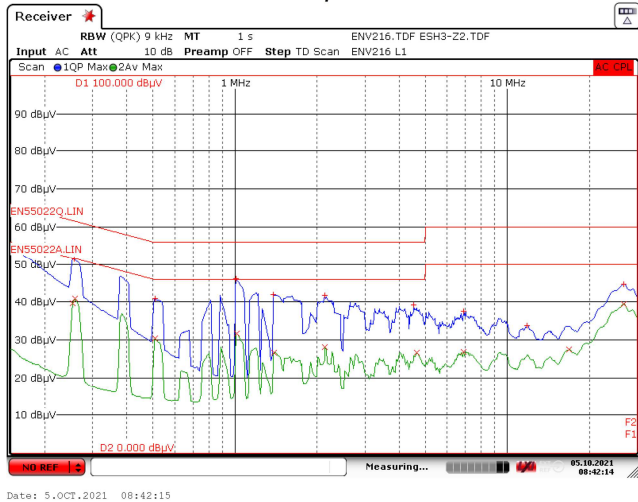
### 14.3 Output Grounded



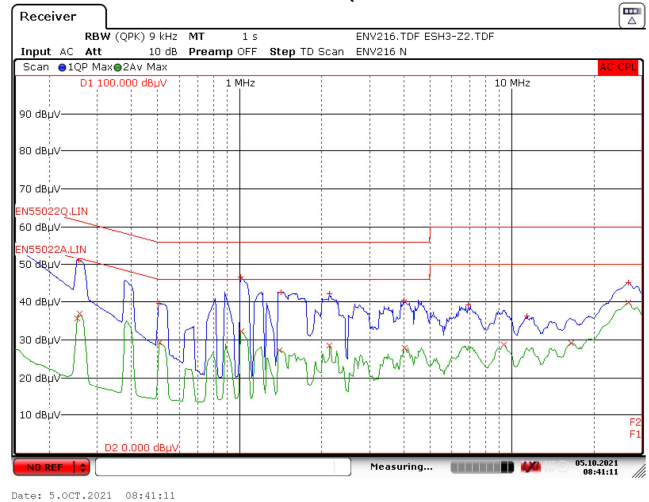
**Figure 153** – 115 VAC 60 Hz.  
Line with Output Grounded.



**Figure 154** – 115 VAC 60 Hz.  
Neutral with Output Grounded.



**Figure 155** – 230 VAC 60 Hz.  
Line with Output Grounded.



**Figure 156** – 230 VAC 60 Hz.  
Neutral with Output Grounded.

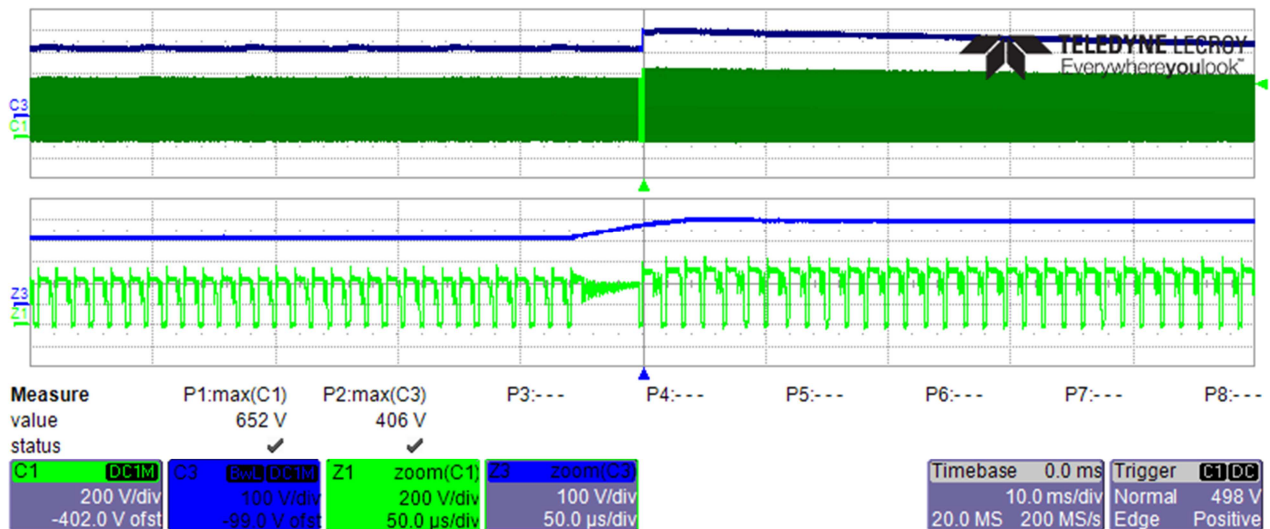
## 15 Line Surge

IEC61000-4-5 differential mode and common mode input line surge testing was completed on a single test unit. Input voltage was set at 230 VAC / 60 Hz. Output was loaded at full load and operation was verified following each surge event.

### 15.1 Differential Mode Surge

DM Surge Level (V)	Input Voltage (VAC)	Injection Location	Injection Phase (°)	Test Result (Pass/Fail)
+1000	230	L to N	0	Pass
-1000	230	L to N	0	Pass
+1000	230	L to N	90	Pass
-1000	230	L to N	90	Pass
+1000	230	L to N	180	Pass
-1000	230	L to N	180	Pass
+1000	230	L to N	270	Pass
-1000	230	L to N	270	Pass

**Note:** In all PASS results, power supply is still functional after the test.



**Figure 157** – Differential Mode Surge Input AC and  $V_{DS}$  Waveform.

Ch1:  $V_{DS}$  200 V / div., 10 ms / div.

Ch2: Bulk Voltage 100 V / div., 10 ms / div.

Zoom: 50  $\mu$ s / div.

$V_{DS(MAX)}$ : 652 V.

15.2 **Common Mode Surge**

Surge Voltage (kV)	Phase Angle (°)	IEC Coupling	Generator Impedance ( $\Omega$ )	Number of Strikes	Result
+2	0	L, N - PE	12	10	PASS
-2	0	L, N - PE	12	10	PASS
+2	90	L, N - PE	12	10	PASS
-2	90	L, N - PE	12	10	PASS
+2	270	L, N - PE	12	10	PASS
-2	270	L, N - PE	12	10	PASS

**Note:** In all PASS results, power supply is still functional after the test.

16 **ESD**

All ESD strikes were applied at end of cable with 230 VAC input voltage and full load.

Passed  $\pm 8$  kV contact discharge

Contact Discharge Voltage (kV)	Applied to	Number of Strikes	Test Result
+8.0	12 V	10	PASS
-8.0	12 V	10	PASS
+8.0	GND	10	PASS
-8.0	GND	10	PASS

**Note:** In all PASS results, power supply is still functional after the test.

Passed  $\pm 15$  kV air discharge

Air Discharge Voltage (kV)	Applied to	Number of Strikes	Test Result
+15	12 V	10	PASS
-15	12 V	10	PASS
+15	GND	10	PASS
-15	GND	10	PASS

**Note:** In all PASS results, power supply is still functional after the test.



## 17 Revision History

Date	Author	Revision	Description and Changes	Reviewed
02-Feb-22	RPA/RPL	1.0	Initial Release.	Apps & Mktg



**For the latest updates, visit our website: [www.power.com](http://www.power.com)**

Reference Designs are technical proposals concerning how to use Power Integrations' gate drivers in particular applications and/or with certain power modules. These proposals are "as is" and are not subject to any qualification process. The suitability, implementation and qualification are the sole responsibility of the end user. The statements, technical information and recommendations contained herein are believed to be accurate as of the date hereof. All parameters, numbers, values and other technical data included in the technical information were calculated and determined to our best knowledge in accordance with the relevant technical norms (if any). They may be based on assumptions or operational conditions that do not necessarily apply in general. We exclude any representation or warranty, express or implied, in relation to the accuracy or completeness of the statements, technical information and recommendations contained herein. No responsibility is accepted for the accuracy or sufficiency of any of the statements, technical information, recommendations or opinions communicated and any liability for any direct, indirect or consequential loss or damage suffered by any person arising therefrom is expressly disclaimed.

Power Integrations reserves the right to make changes to its products at any time to improve reliability or manufacturability. Power Integrations does not assume any liability arising from the use of any device or circuit described herein. POWER INTEGRATIONS MAKES NO WARRANTY HEREIN AND SPECIFICALLY DISCLAIMS ALL WARRANTIES INCLUDING, WITHOUT LIMITATION, THE IMPLIED WARRANTIES OF MERCHANTABILITY, FITNESS FOR A PARTICULAR PURPOSE, AND NON-INFRINGEMENT OF THIRD PARTY RIGHTS.

**Patent Information**

The products and applications illustrated herein (including transformer construction and circuits' external to the products) may be covered by one or more U.S. and foreign patents, or potentially by pending U.S. and foreign patent applications assigned to Power Integrations. A complete list of Power Integrations' patents may be found at [www.power.com](http://www.power.com). Power Integrations grants its customers a license under certain patent rights as set forth at <http://www.power.com/ip.htm>.

Power Integrations, the Power Integrations logo, CAPZero, ChiPhy, CHY, DPA-Switch, EcoSmart, E-Shield, eSIP, eSOP, HiperPLC, HiperPFS, HiperTFS, InnoSwitch, Innovation in Power Conversion, InSOP, LinkSwitch, LinkZero, LYTSwitch, SENZero, TinySwitch, TOPSwitch, PI, PI Expert, SCALE, SCALE-1, SCALE-2, SCALE-3 and SCALE-iDriver, are trademarks of Power Integrations, Inc. Other trademarks are property of their respective companies. ©2019, Power Integrations, Inc.

**Power Integrations Worldwide Sales Support Locations****WORLD HEADQUARTERS**

5245 Hellyer Avenue  
San Jose, CA 95138, USA.  
Main: +1-408-414-9200  
Customer Service:  
Worldwide: +1-65-635-64480  
Americas: +1-408-414-9621  
e-mail: [usasales@power.com](mailto:usasales@power.com)

**CHINA (SHANGHAI)**

Rm 2410, Charity Plaza, No. 88,  
North Caoxi Road,  
Shanghai, PRC 200030  
Phone: +86-21-6354-6323  
e-mail: [chinasales@power.com](mailto:chinasales@power.com)

**CHINA (SHENZHEN)**

17/F, Hivac Building, No. 2, Keji  
Nan 8th Road, Nanshan District,  
Shenzhen, China, 518057  
Phone: +86-755-8672-8689  
e-mail: [chinasales@power.com](mailto:chinasales@power.com)

**GERMANY (AC-DC/LED Sales)**

Einsteinring 24  
85609 Dornach/Aschheim  
Germany  
Tel: +49-89-5527-39100  
e-mail: [eurosales@power.com](mailto:eurosales@power.com)

**GERMANY (Gate Driver Sales)**

HellwegForum 1  
59469 Ense  
Germany  
Tel: +49-2938-64-39990  
e-mail: [igbt-driver.sales@power.com](mailto:igbt-driver.sales@power.com)

**INDIA**

#1, 14<sup>th</sup> Main Road  
Vasanthanagar  
Bangalore-560052  
India  
Phone: +91-80-4113-8020  
e-mail: [indiasales@power.com](mailto:indiasales@power.com)

**ITALY**

Via Milanese 20, 3<sup>rd</sup>. Fl.  
20099 Sesto San Giovanni (MI) Italy  
Phone: +39-024-550-8701  
e-mail: [eurosales@power.com](mailto:eurosales@power.com)

**JAPAN**

Yusen Shin-Yokohama 1-chome Bldg.  
1-7-9, Shin-Yokohama, Kohoku-ku  
Yokohama-shi,  
Kanagawa 222-0033 Japan  
Phone: +81-45-471-1021  
e-mail: [japansales@power.com](mailto:japansales@power.com)

**KOREA**

RM 602, 6FL  
Korea City Air Terminal B/D,  
159-6  
Samsung-Dong, Kangnam-Gu,  
Seoul, 135-728 Korea  
Phone: +82-2-2016-6610  
e-mail: [koreasales@power.com](mailto:koreasales@power.com)

**SINGAPORE**

51 Newton Road,  
#19-01/05 Goldhill Plaza  
Singapore, 308900  
Phone: +65-6358-2160  
e-mail: [singaporesales@power.com](mailto:singaporesales@power.com)

**TAIWAN**

5F, No. 318, Nei Hu Rd.,  
Sec. 1  
Nei Hu District  
Taipei 11493, Taiwan R.O.C.  
Phone: +886-2-2659-4570  
e-mail: [taiwansales@power.com](mailto:taiwansales@power.com)

**UK**

Building 5, Suite 21  
The Westbrook Centre  
Milton Road  
Cambridge  
CB4 1YG  
Phone: +44 (0) 7823-557484  
e-mail: [eurosales@power.com](mailto:eurosales@power.com)

